

**MINISTRY OF EDUCATION, YOUTH AND SPORT**

**អេស៊ីណីដា**  
**BUSINESS 1 INSTITUTE**



# **AIB RESEARCH SERIES**

**VOLUME III**

**PHNOM PENH, 2023**

## **EDITORS AND REVIEWERS**

### **Editorial Board**

Dy Samsideth, Ph.D., Chair	Ministry of Education, Youth and Sport
Prof. Dr. Heng Kreng, Vice-Chair	Ministry of Education, Youth and Sport
Phon Narin, Ph.D.	ACLEDA Institute of Business
Rath Rattanak	ACLEDA Institute of Business
Nornng Phirum	ACLEDA Institute of Business

### **Editors-in-Chief**

Assoc. Prof. Dr. Sam Chanphirun	Phnom Penh Teacher Education College
Assoc. Prof. Dr. Heng Kimkong	Ministry of Education, Youth and Sport

### **Associate Editors**

Nornng Sokha, Ph.D.	ACLEDA Institute of Business
Ngam Phorn	ACLEDA Institute of Business

### **Peer Reviewers**

Daiju Aiba, Ph.D.	Waseda University, Japan
Al Muizzuddin Fazaalloh, Ph.D	Nagoya University, Japan
Prof. Dr. Chhay Phang	National University of Management
Assoc. Prof. Dr. Sau Lay	National University of Management
Hor Chantha, Ph.D.	ACLEDA Bank Plc.
Sam Chinho, Ph.D.	Pannasastra University of Cambodia
Long Bunteng, Ph.D.	Western University
Thath Rido, Ph.D.	Royal University of Phnom Penh

## **Key Remarks from Managing Director of ACLEDA Institute of Business (AIB)**

ACLEDA Institute of Business (AIB), a leading business school with the highest quality standard to develop future generations to support the socio-economic development in Cambodia and the Region, is a subsidiary companies of ACLEDA Bank Plc, which was recognized by the Royal Government of Cambodia in 2016 as a private higher education institution transformed from ACLEDA Training Center (ATC). The mission of AIB is to provide learners with the superior quality of higher education services and professional training in business education so that they can develop their knowledge, skills, experiences, ethics and networking in order to enhance their professional future careers.

As the basis of applied research has currently been a central focus in order to transform Cambodia into a digital economy, AIB has been committed to taking part in contributing to promote a research culture of Cambodia in line with its vision and mission. AIB has integrated industry attachment and lifelong learning into teaching and learning curriculum and extracurricular activities. For instance, the programs of AIB are conducted by using problem-based, inquiry-based, and project-based learning, mini-research, and presentations.

As part of a strategic leadership, AIB has encouraged outstanding students to conduct thesis writing in order to fulfill their graduate requirements; and several of the top quality papers have been selected systematically by using a double-blind review and editorial process, so that they could be published in the AIB Research Series. Furthermore, AIB has integrated research publications into the career development scheme, especially for full-time faculty members, so that they could be promoted from a senior lecturer to an assistant professor and all the ways up to a professor title.

Last but not least, AIB is going to publish the Research Series two issues per volume annually; moreover, local and regional researchers will be invited to publish their work in AIB Research Series so that an academic community can be initially created and sustainably developed in Cambodia and the region.



Phon Narin, Ph.D.  
Managing Director

## **Key Remarks from the Editorial Board**

The Academic Affairs Committee is a technical arm of the Board of Directors of AIB to provide advice on teaching, learning and research. The quality and relevance of teaching and learning are our priority to ensure that students will become useful citizens and be well accepted in the world of work after their graduation from AIB. We are committed to the empowerment of the faculty members through capacity building and professional development for the betterment of their respective services.

AIB Research Series is the first attempt to promote a sharing of knowledge. Against this backdrop, I would like to emphasize that authors take weeks, months and years to conduct research and write research articles, but we as readers may spend only a few hours and days to read and comprehend their articles. Thus, I would like to congratulate all authors for their efforts and I also encourage all readers to read with interest for professional development.

On behalf of the Committee, I would like to wish the faculty members and the students of AIB every success in their future endeavours.



Dy Sam Sideth, Ph.D.

Chairman of the AACO and Editorial Board

## Remarks from the Editors-in-Chief

We are delighted to publish a new volume (Volume 3) of the AIB Research Series. On behalf of the AIB Editorial Team, we would like to extend a very warm welcome to the readership of the AIB Research Series. We would also like to take this opportunity to express our sincere thanks to all board members, editors, authors, and reviewers of the AIB Research Series, all of whom have contributed to the success of this journal. The AIB Research Series is developed in line with one of the missions of the ACLEDA Institute of Business (AIB) to promote research activities within its academic community to ensure quality education.

AIB Research Series primarily focuses on research examining issues centering around the field of business. This provides a crucial forum to address important issues, share research findings, and discuss various aspects in business, from which the readership in the field can benefit.

This volume contains eight research articles covering a variety of research topics, including university-industry linkages in research, impacts of credits on economic growth, usage of QR code payment, factors influencing customer loyalty of coffee shops, efficiency of an asset pricing model, customers' satisfaction with ATM services, customers' satisfaction in using debit cards, and the impact of self-service banking quality on customer satisfaction.

We believe that the regular publication of the AIB Research Series involving various topics will pave the way for AIB to become a leading institution in academic research and development in Cambodia.



Assoc. Prof. Dr. Sam Chanphirun

Editor-in-Chief



Assoc. Prof. Dr. Heng Kimkong

Editor-in-Chief

## TABLE OF CONTENTS

1. Challenges and Opportunities of University-Industry Linkages in the Research Field: A Collaboration between a Higher Education Institution and Commercial Banks <i>By Sokha Norng, Narin Phon, Pisith Hok, and Chanphirun Sam.....</i>	1 – 13
2. The Impact of Credits on the Economic Growth in Cambodia <i>By Chanrey Pang, Pisith Hok, Mady Sen, Sokhom Ma, and Chandara Sam.....</i>	14 – 31
3. Factors Influencing Customer Usage of QR Code Payment: A Case Study of ACLEDA Institute of Business Students <i>By Bun Khem, Lundy Sem, Phirum Norng, Dina Lim, and Soren Chea.....</i>	32 – 48
4. Factors Influencing Customer Loyalty of Coffee Shops in Phnom Penh City <i>By Sinit To, Phirum Norng, Raingsey Keo, Vanda Vong, and Soren Chea.....</i>	49 – 61
5. An Empirical Test of the Efficiency of the Asset Pricing Model for Cambodia Securities Exchange (CSX) <i>By Chinho Sam, Pisith Hok, Sovitu Sam, Sethvannak Sam, and Channa Lim.....</i>	62 – 78
6. Customers' Satisfaction with ATM Service Quality of ACLEDA Bank <i>By Satya Somatin Chhnoeum, Raingsey Keo, Muoyseam Chang, Soren Chea, and Sinit To.....</i>	79 – 93
7. The Impact of Service Quality Dimensions on Customers' Satisfaction to Use Debit Cards in Phnom Penh City <i>By Keo Kriss, Sovuthiroth Hean, Chanvorleak Nhem, and Sokha Norng...</i>	94 – 111
8. The Impact of Self-Service Banking Quality on Customer Satisfaction: Evidence from ACLEDA Bank Plc. <i>By Chanpov Ou, Evanuk Sarath, Muniroth Vorn, and Phorn Ngam.....</i>	112 – 133



# Challenges and Opportunities of University-Industry Linkages in the Research Field: A Collaboration between a Higher Education Institution and Commercial Banks

Sokha Norng<sup>1</sup>, Narin Phon<sup>1</sup>, Pisith Hok<sup>1</sup>, and Chanphirun Sam<sup>2</sup>

Corresponding Author. Email: norng.sokha@acleda-aib.edu.kh

<sup>1</sup> ACLEDA INSTITUTE OF BUSINESS, Phnom Penh, Cambodia

<sup>2</sup> Phnom Penh Teacher Education College, Phnom Penh, Cambodia

## ABSTRACT

*University-industry linkages (UILs) in the research field significantly contribute to the needs of the industry and society. However, little is known about its practice in the context of Cambodia. Therefore, this study aims to explore the challenges and opportunities concerning the linkage between a higher education institution and a banking industry for research purposes. The study takes ACLEDA Institute of Business (AIB) as a case study because research activities have become its strategic priority. The study employs a qualitative approach by conducting expert interviews with key informants and document analysis. By using a thematic method in analyzing the data, the study found that the key challenges that AIB faced in collaborating research with the banking industry included the current bank's competitive strategy, which has yet to prioritize UILs; patents and commercialization in research and development (R&D) and technology transfers, which embrace innovation or disruptive technology in order to create new products or services. However, there is still room for AIB to collaborate with the banking industry and relevant sectors.*

**Keywords:** University-industry linkages, University research management, Applied research, ACLEDA Institute of Business



## 1. Introduction

### *Background of the study*

Universities drive economic growth in the United Kingdom and worldwide (Witty, 2013) and economic development “through education and technology absorption, adaptation, and diffusion (Yusuf, 2007, p. 3). As a modern society moves toward a knowledge-based economy, the universities focus on three missions, namely teaching, research, and entrepreneurship (Guimón, 2013). In order to facilitate economic growth, all universities have to embrace the third mission (Witty, 2013). Sam and Sijde (2014) noted that “the university is a supplier of human capital (graduates), knowledge (research) and in the provision of (incubation) space for new enterprises” (p. 902).

Many universities have moved beyond the “traditional teaching and research toward a third mission” because they want to address the need of the industry (Guimón, 2013). The connection between a research activity and the industry is so-called university-industry linkages (UILs), which Korff (2014) refers to “collaboration between a university and industry partner” (p. 282). UILs can push “commercialization of public R&D (research and development) outcome and increase the mobility of labor between public and private sector.” (Guimón, 2013, p.1) This benefits can be seen in developing countries, such as Chile and Colombia (Guimón, 2013). Likewise, in Thailand, its Higher Education Development Project (HEDP) has strengthened both “core academic missions and UILs activities within newly founded centers” (Schiller & Brimble, 2009, p.59).

### *Problem statement*

In Cambodia, UILs have recently been emphasized by the Ministry of Education, Youth and Sport (MoEYS) and public and private Higher Education Institutions (HEIs). The improvement of the higher education curriculum to meet industry needs has been addressed in the sub-theme of the Higher Education Improvement Project (HEIP), which attempts to improve the quality and relevance of higher education and research, mainly in science, technology, engineering and mathematics (STEM) and agriculture. The Higher Education Quality and Capacity Improvement Project (HEQCIP) and the Department of Scientific Research (DSR) of MoEYS have also focused on UILs in the 2<sup>nd</sup> and 3<sup>rd</sup> National Conference on Research and Innovation in Cambodia.

MoEYS has begun to focus on research because Cambodia still falls behind other countries in the region in terms of research and publications (Heng & Sol, 2021). With the lack of research publications, Cambodia has currently faced another challenge; that is, the need to link research with the industry, addressed at the 3<sup>rd</sup> National Conference on Research and Innovation in

Cambodia by Dr. Heng Kreng, Director of DSR. In order to solve the issue of limited academic research publication, stakeholder involvement is indeed needed ( Heng, 2020; Sam & Dahles, 2017 ). However, little is known about the issue of UILs in research in Cambodia, especially at the institutional level. Which role do HEIs play in order to promote UILs in research? What are the challenges and opportunities for HEIs in promoting UILs in research?

### *Research setting*

This study focuses on UILs at the ACLEDA Institute of Business (AIB). As a subsidiary of the ACLEDA Bank Plc., AIB was recognized by the MoEYS in 2016 as a HEI providing academic services such as master's degrees, bachelor's degrees, and associate's degrees. Two offices of AIB dealing with UILs are the Student Support Service (SSS) and the Centre for Research & Innovation (CRI).

Moreover, the study determines an industry linkage by including two commercial banks. The reasons that the two commercial banks are selected because they value the research activities and they support education activities as part of their corporate social responsibilities. Both commercial banks have been founded by Cambodian entrepreneurs. One commercial bank has been in the bank industry for 30 years by transforming from a micro finance institution to a specialize bank in 2000 and then to the commercial bank in 2003. The second one has been in the bank industry since 2008 as a money transfer business. Then it has upgraded to a specialized bank in 2014 and to a commercial bank in 2020.

### *Research objective*

To explore the challenges and opportunities concerning the linkage between a higher education institution and a banking industry, this study takes the ACLEDA Institute of Business (AIB) as a case study.

### *Research questions*

This study has two research questions:

Which role does AIB play in order to promote UILs?

What are the challenges and opportunities for AIB in promoting UILs with commercial banks?

## 2. Literature Review

### *Definitions of university-industry linkages (UILs)*

Mostly, UILs are referred to as a commercialization activity such as patenting and licensing and the incubator (Göktepe-Hulten & Mahagaonkar, 2010), while Korff et al. (2014) noted that UILs can be referred to as all types of activities, collaborated by a university and other partners; thus, the definition of UIL is expanded to a “collaboration in R&D, commercializing R&D, mobility of students and staff, curriculum development and delivery, entrepreneurship, governance and lifelong learning” (Davey et al., 2011, p. 27). Based on this definition, this study seeks insight into the collaboration in R&D between the university, namely the ACLEDA Institute of Business and business partners in the field of finance and banking.

### *Challenges for university-industry research*

Since UILs in research is a new phenomenon in developing countries, particularly Cambodia, the collaboration between firms and universities are likely to meet several challenges.

First of all, firms are interested in applied research, whereas universities focus on basic research (Guimón, 2013). Applied research is conducted for fast commercial results (Guimón, 2013) or when a decision must be made about a specific real-life problem (Sekaran & Bougie, 2016). Applied research, including action research, evaluation research, or R&D (targeting market’s needs), is conducted to solve problems at the workplace, education or society (Indeed, 2021). On the other hand, basic research attempts to expand the limits of knowledge (Sekaran & Bougie, 2016). It examines how a process or a concept works; and the findings of basic research “creates a foundation for applied research” (Indeed, 2021).

Secondly, firms want to the research results developed into new patents or new products quickly and want to “delay publications to avoid disclosing information,” whereas university researchers want to publish their research results immediately (Guimón, 2013) as they want to show their achievements to the research community.

Thirdly, there is an obstacle in terms of collaboration between firms and universities due to difficulties in negotiations such as “lack of information, difficulties finding contact persons, and transaction cost of finding the right partner” (Guimón, 2013, p. 4).

Fourthly, firms are “concerned about secrecy and misalignment of expectations with regard to intellectual property (IP) rights and making a profit from them.” (Guimón, 2013, p.4). This is due to the fact that newer and smaller universities have “small industrial liaison offices and could not afford to have dedicated staff who could properly manager and exploit the intellectual property and technology being generated by their universities” (Howells et al., 1998, p. 62).

There is another fear that some firms view the universities as the threat of the new entrants. They have created a new company as a result of succession of their incubator. This spin-off firm is likely to exploit the research results produced by its own parents (the universities).

Fifthly, the collaboration is considerably costly and the returns can be either medium or long terms, whereas most firms wish to see “the short-term results and clear contributions to their current business lines” from their high expense on research (Guimón, 2013, p.4).

Last but not least, most universities do not have enough budgets to invest in their UIL research activities. According to Intarakumnerd and Schiller (2009), public funding for universities fulfilling their demand is limited, which negatively impacts the academic capability building in technological capabilities, public policies, and start-up financing.

#### *Challenges of research collaboration in Cambodia*

Previous studies have identified another challenge in research collaboration, which is the limited stakeholder involvement. According to Sam and Dahles (2017), “despite the involvement of the four major stakeholder categories, collaboration has remained weak and hence failed to advance the sector” (p. 17). There is a lack of clear mechanism to promote the collaboration, and the industries are considered passive in this collaboration because of their resource and capacity limitations (Sam & Dahles, 2017). Likewise, Heng (2020), also noted the limited research capacity of Cambodia HEIs and academics as well as the limited stakeholder collaboration. According to Sam and Dahles (2017), HEIs are expected to be key players in collaboration; however, they are not resourceful and proactive enough.

#### *Motivation for university-industry research collaboration*

Despite the challenges, there are several reasons leading to UILs or university-industry research collaboration. UILs have benefits for both firms and universities.

One of the reasons for firms to collaborate with universities is that they can gain access to complementary technological knowledge, including patents and tacit knowledge, access to the universities’ facilities and equipment, access to public funding and incentives, reduction in risks by sharing costs of R&D, and the facilitation of good community relations (Atlan, 1987; Guimón, 2013).

Furthermore, according to Guimón (2013), several benefits that the universities can gain from the UILs in research include “the improvement of teaching, the access to funding, reputation enhancement, and the access to empirical data from the industry” (p. 4). AbebeAssefa (2016) also noted that:

*[...industry provides a new and additional source of fund for university, universities relationship with the industry, reduce governments' responsibility for the economic support of university research, industrial money involves less "red tape" than government treasury, industrially sponsored research provides student with exposure to real world research problems, industrially sponsored research...]* (Atlan, 1987, p.10)

Despite the challenges and benefits of UILs, previous studies have provided some suggestions: the mission of each partner should be supported; long-term partnerships should be fostered; and the benefits of each party should be focused (Guimón, 2013). The government should take a lead in promoting research (Heng, 2020) and promoting stakeholder collaboration (Sam & Dahles, 2017). Industries and non-governmental organizations (NGOs) have to be actively involved in providing inputs for HEIs to produce qualified graduates, and HEIs have to constantly build staff capacity and mobilize their resources to attract potential collaborations (Sam & Dahles, 2017).

### **3. Method**

#### *Research design*

This study employed a qualitative method, in which the researchers "collect data themselves through examining documents and interviewing participants" (Creswell, 2014). The study reviewed previous studies and relevant documents by using the existing themes to create the investigative questions in order to design the interview guide.

#### *Research participants*

The study employed purposive sampling, in which participants were selected based on their unique characteristics (Schindler, 2019). The study selected three key participants who had many years of experiences in the banking industry. The first participant has been working with ACLEDA Bank Plc. for more than 20 years, and he used to be the CEO of Laos ACLEDA Bank Plc. for 9 years. He has led AIB for 5 years. The second participant is the Head of the Strategic Development Division at a commercial bank in Phnom Penh city. He has experience in the banking industry for more than 20 years. The third participant is the Deputy CEO of another commercial bank in Phnom Penh city. He has also been working in the banking sector for 15 years.

#### *Research tools*

The study used unstructured interviews. Sam (2017) noted that interviews provide interaction setting for exploring experiences and perspectives of their partners (see also Schostak, 2005). Moreover, the unstructured interviews allow "the interviewee to talk from their own perspective

using their frame of reference and ideas and meanings that familiar to them” (Edwards & Holland, 2013, p.30). The interviews included themes related to types of research conducted at the bank, types of data required, research needs, challenges and opportunities in the collaboration between the banks and AIB.

#### *Data collection*

The study collected primary data from the responses of the three participants. The study, first of all, asked the first key participant to explore the research activities currently implemented at Institute and strategies to promote research activities as well as UILs in research. Then the study designed a letter of request and a consent form and sent these forms to the other two key participants of the commercial banks. Due to the COVID-19 pandemic, the interviews were conducted online via Zoom and the researchers asked the key participants to record the interviews. The interviews were conducted from the second week of September to the second week of October 2021.

#### *Data analysis*

To explore the insights of the challenges and opportunities of UILs in research, the study coded and analyzed the data by using a theme-based analysis (Braun & Clarke, 2006). The theme on types of research and type of data required were coded as TH01 and TH02, respectively. Moreover, the theme on research needs, challenges opportunities in the collaboration, and strategies to promote UILs in research were coded as TH03, TH04, TH05, and TH07, respectively. Furthermore, the first key participant was coded as P1, Head of Strategic Development Division was coded as P2, and Deputy CEO was coded as P3. Finally, the data were interpreted and compared to the previous studies.

## **4. Findings and Discussions**

#### *Types of research*

In order to capture the overall picture of UILs research, the study found that the tasks of research are the responsibility of the Product and Marketing Department in one commercial bank and the Strategic Planning Division in another commercial bank. All of the participants remarked that research plays an important role at the banks as it helps top leaders make effective decisions. P2 stated:

*“Research is important for the bank. First, it improves the policy, operating manuals and procedures, understand the market theory, operational situation and perception... Second, the findings from the SWOT analysis are used for developing and solving, competitive trend, pricing, product trend, technology, etc.”*

Therefore, the banks need both basic research and applied research. As P2 stated,

*“We do both. The basic research is conducted for improving and understanding the issue, and the applied research is conducted for problem solving, gaining market insights, and so forth.”*

Furthermore, both types of research have been conducted in order to understand customers’ behavior and satisfaction so that new products are well-developed and upgraded. As P3 stated,

*“The digital payment service has been developed with an understanding of customers’ wants and it has gained popularity among clients so far.”*

The commercial banks participating in this study have prioritized patents, commercialization in R&D, and technology transfers. The banking industries have to innovate their products and services constantly so that they fulfill the market needs. They raised an example of a mobile banking app which was introduced to the market in 2009, and they have continuously improved this service until today. However, they have worked with industry experts in order to build and develop this innovative product, and they have not worked with higher education institutions in Cambodia to create a new products or services.

To ensure the quality research outputs, the study found that both primary and secondary data are required by both commercial banks. According to P3, his bank needs to conduct a market survey among the households and collect statistical data from the index. Likewise, as P2 stated,

*“We use both data such as pricing, product achievement, market share, compared growth, involved statistic, etc.”*

The study also found that one commercial bank focuses on micro-environment factors, while another commercial bank focuses on both macro-and-micro-environment factors as crucial information supporting decision making. As P2 stated,

*“It depends on which objective that the SWOT need to be involved. If we do SWOT (in feasibility study) for product, it's local analysis and SWOT for cross border or international payment, we shall add information of regional and global information. It can be used both local and regional or peer group of countries for SWOT on Opportunities and Threats.”*

#### *Findings on the Collaboration between Banks and Universities*

The study found that both commercial banks have collaborated with the Ministry of Education, Youth and Sport (MoEYS) in different fields other than research. For instance, one commercial bank has collaborated with MoEYS on “Entrepreneurship Competition” and another

commercial bank has taken part in “Building the quality of education.” Both commercial banks have offered the internship and job opportunities to any HEIs in Cambodia.

The collaboration has not only been initiated by the banks, as AIB has also worked closely with the industries, particularly the banking sector. For instance, AIB signed an MOU with a commercial bank to allow its students to do internship/apprenticeship. AIB also collected inputs from a commercial bank and other employers in order to design and review its academic curriculum. As P1 stated,

*“AIB signed MOU with 93 private sectors including ACLEDA Bank Plc. and its subsidiaries. AIB has constantly collected feedbacks on the work performance of its students from the employers.”*

#### *Findings on the challenges in UILs in research*

The demand for UILs in research is considerably low. Even though both commercial banks positively view the research collaboration between the banks and the universities, they have not integrated this possible collaboration into their strategic plan yet. As P2 stated,

*“It’s a good idea to have such a collaboration, but we do not have plan yet.”*

According to Guimón, (2013), there are several obstacles in university-industry research collaboration, namely mismatches between firms and universities related to research orientation, costly collaboration, different purposes of research outputs, concern of intellectual property (IP), and difficulties in collaboration negotiation. Stakeholder involvement is another challenge in the collaboration (Heng, 2020; Sam & Dahles, 2017). The industries themselves are passive due to their resources and capacity limitations, while HEIs are not active players (Sam & Dahles, 2017) and they have limited research capacity (Heng, 2020).

However, the findings of this study contradict those of Guimón (2013). Both basic and applied research are required by the commercial banks, but these types of research are conducted by using the internal resources only. Currently, they have not had the plan for UIL in research yet; therefore, none of the reasons addressed by Guimón (2013) have been found in this study.

Furthermore, the findings of this study slightly support those of Sam and Dahles (2017) and Heng (2020); however, this study fully support their suggestions since the research activities have been participated by stakeholders at the institutional level as found in the case at AIB. The shareholders, Board of Director and the management have strongly supported research activities by formulating strategies to promote both basic and applied research. They even allocate annual budget to support the process and product of research. At the national level, the Education Research Council (ERC) was established to promote insightful thinking and innovative ideas.



For example, ERC has regularly published a journal, called Cambodia Education Review (Heng & Sol, 2021). The HEIP project has also been implemented to promote research in STEM and agriculture at higher education. The Department of Scientific Research has particularly played an active role in promoting research activities in higher education (Heng & Heng, 2023).

#### *Findings on the opportunities for UILs in research*

Besides the challenges, there are still floor for the universities to collaborate with firms, especially in the banking sector. The study found that both commercial banks had a positive opinion about the collaboration between banks and universities. Banks view universities as the collective of intellectuals that bridge the connection between theories and practices in order to embrace innovation. As P2 stated,

*“...yet this academic theory is valuable if utilized to reflect the society’s needs since it can be used to develop a new product. Moreover, the university is a new impressive idea, which brings about new innovation as a bridge between theory and practice in the banking sector...”*

Furthermore, the study found that the future collaboration between banks and universities could happen if the universities conduct the study on the needs for this collaboration. As P2 stated,

*“The future collaboration sounds good and we need to talk on the possibility or research need assessment.”*

Even though these findings do not support what was mentioned by Atlan (1987) and Guimón (2013), there are some insights worth considering. As HEIs are the hubs of knowledges, they are able to create new and innovative knowledge through their original research; moreover, they can work with the industries to create the demands for them.

#### *Findings on strategies to promote UILs in research*

The study found that there is still floor for AIB to promote research collaboration with the industry. The key participants requested AIB to conduct the assessments of research needs to identify the gap with the banks; moreover, they suggested AIB to take the initiative in this collaboration for the coming future. As P2 and P3 emphasized,

*“AIB should take the initiative by being proactive rather than reactive in the future research collaboration.”*

In addition, to sustain future collaboration in research, each partner has to be strong and qualified. AIB starts promoting research activities through research publications; for instance, eight research articles were published in AIB Research Series (Volume 1) and 11 research

articles were published at AIB Research (Volume 2). Moreover, several articles have been posted at the Business News Category of AIB's website; however, these research activities are not enough yet. As P1 stated,

*“AIB has to promote both quantity and quality of the research. AIB needs to use the research quality as one of the means to promote the image to the local and international partners.”*

Norng and Sam (2022) found that research productivity at AIB is at the infant stage; therefore, AIB can strengthen their research productivity through building the quality of research and mobilizing experienced researchers. This action allows AIB to create and transfer knowledge to the industry.

## **5. Conclusion and Recommendations**

Research collaboration between AIB and the industry, namely the banking sector, has not existed yet. This may come from both the internal and external factors. Before and after COVID-19, research and publication in Cambodia fall behind several other countries in the region and very few higher education institutions focused on research activities. Therefore, research quantity and quality still matter in the Cambodian higher education context. During and after the pandemic, all stakeholders have taken part in promoting research activities. Many public and private higher education institutions, including the ACLEDA Institute of Business (AIB), have included research activities into their strategic priorities. However, research quality is the challenging internal factor for AIB since it is a newly established institution and research productivity is still in its infancy. Besides this internal factor, external factors have been the challenges as found in this study. The commercial banks participated in this study have conducted both basic and applied research; however, they have not prioritized university-industry linkages (UILs) in research yet. They used to work with independent research institutes but not much with the higher education institutions. Another external issue is the technological environment in Cambodia, namely research patents, commercialization in R&D, and technology transfers, which embrace innovation or disruptive technology in order to create new products or services. The commercial banks would work with the industrial experts rather than the higher education institutions to develop their new products or services.

Besides all of these challenges, the opportunities are more likely to exist in the long run. There is still room for AIB to collaborate with the banking industry and relevant sectors in the research field only if AIB takes the initiative by adapting a proactive approach rather than a reactive approach.

Moreover, AIB should conduct assessment of the needs on UILs in research by identifying which area that this new established higher education institution can collaborate with the banks

or relevant industries. AIB can also build a research team by mobilizing experienced researchers so they can create and transfer knowledge to the industry. Finally, AIB should develop a long-and-medium term strategic plan in order to promote applied research.

### References

- AbebeAssefa, A. (2016). University-industry linkage practices, determinants and challenges theoretical and empirical article review: Lessons for effective and successful collaboration. *International Journal of Research in Management*, 6(3), 1–16.
- Atlan, T. (1987). Bring together industry and university engineering schools. *Getting More Out of R&D and Technology, The Conference Board, Research Report*, 904.
- Braun, V., & Clarke, V. (2006). Using thematic analysis in psychology. *Qualitative Research in Psychology*, 3(2), 77–101.
- Creswell, J. W. (2014). *Research design: qualitative, quantitative, and mixed methods approaches. 4th ed.* SAGE Publications, Inc.
- Davey, T., Baaken, T., Deery, M., & Galán-Muros, V. (2011). 30 Best Practice Case Studies in University-Business Cooperation. *European Commission, DG Education and Culture: Brussels, Belgium.*
- Edwards, R., & Holland, J. (2013). *What is qualitative interviewing?* Bloomsbury Publishing Plc.
- Göktepe-Hulten, D., & Mahagaonkar, P. (2010). Inventing and patenting activities of scientists: in the expectation of money or reputation? *The Journal of Technology Transfer*, 35(4), 401–423.
- Guimón, J. (2013). Promoting university-industry collaboration in developing countries. *World Bank-Policy in Brief*, 3, 12–48.
- Heng, K. (2020). *Stakeholder collaboration: The key to promoting academic research in Cambodia.* Cambodia Development Center. [https://cd-center.org/wp-content/uploads/2020/11/P124\\_20201116\\_V2IS20\\_EN.pdf](https://cd-center.org/wp-content/uploads/2020/11/P124_20201116_V2IS20_EN.pdf)
- Heng, K., & Heng, K. (2023). Promoting research in Cambodian higher education: Opportunities, challenges, and policy implications. *Cambodian Journal of Education and STEM*, 1(1), 93-104. In Khmer
- Heng, K., & Sol, K. (2021). Academic research in Cambodia: Progress, challenges, and ways forward. *Cambodian Journal of Educational Research*, 1(2), 6–23.
- Howells, J., Nedeva, M., Georghiou, L., & in Engineering, S. & T. P. R. (1998). *Industry-academic links in the UK.* University of Manchester Manchester PREST.
- Indeed. (2021). *Basic Research vs. Applied Research: Definition and Examples.* Retrieved from <https://www.indeed.com/?from=gnav-career-guide--career-guide-webapp>.
- Intarakumnerd, P., & Schiller, D. (2009). University-industry linkages in Thailand: Successes, failures, and lessons learned for other developing countries. *Seoul Journal of Economics*,

22, page?.

- Korff, N. (2014). *University-industry linkages: benefitting from experience*.
- Korff, N., Van Der Sijde, P., Groenewegen, P., & Davey, T. (2014). Supporting university—industry linkages: A case study of the relationship between the organizational and individual levels. *Industry and Higher Education*, 28(4), 281–300.
- Norng, S., & Sam, C. (2022). Promoting Research Productivity at Cambodian Higher Education Institution from a Leadership Perspective: The Case Study of ACLEDA Institute of Business. *AIB Research Series*, 2, 1-17..
- OECD. (2012). *OECD science, technology and industry outlook 2012*. Paris: OECD Publishing.
- Sam, C. (2017). Cambodian higher education in transition: an institutional governance perspective. *Journal of Enterprising Communities: People and Places in the Global Economy*.
- Sam, C., & Dahles, H. (2017). Stakeholder involvement in the higher education sector in Cambodia. *Studies in Higher Education*, 42(9), 1764–1784.
- Sam, C., & Van Der Sijde, P. (2014). Understanding the concept of the entrepreneurial university from the perspective of higher education models. *Higher Education*, 68(6), 891–908.
- Schiller, D., & Brimble, P. (2009). Capacity building for university--industry linkages in developing countries: The case of the Thai Higher Education Development Project. *Science, Technology and Society*, 14(1), 59–92.
- Schindler, S. P. (2019). *Business Researcher Methods* (13th ed.). McGraw Hill.
- Schostak, J. (2005). *Interviewing and representation in qualitative research*. McGraw-Hill Education (UK).
- Sekaran, U., And, & Bougie, R. (2016). *Research methods for business: A skill-building approach* (7th ed.). John Wiley & Sons Ltd.
- Witty, A. (2013). *Encouraging a British Invention Revolution: Sir Andrew Witty's Review of Universities and Growth*. Retrieved from [https://assets.publishing.service.gov.uk/government/uploads/system/uploads/attachment\\_data/file/249720/bis-13-1241-encouraging-a-british-inven](https://assets.publishing.service.gov.uk/government/uploads/system/uploads/attachment_data/file/249720/bis-13-1241-encouraging-a-british-inven).
- Yusuf, S. (2007). University-industry links, policy dimensions. *How Universities Promote Economic Growth*, 1–26.

## The Impact of Credits on the Economic Growth in Cambodia

Chanrey Pang, Pisith Hok, Mady Sen, Sokhom Ma, and Chandara Sam

Corresponding Author. Email: hok.pisith@acleda-aib.edu.kh  
ACLEDA INSTITUTE OF BUSINESS, Phnom Penh, Cambodia

### ABSTRACT

*This research aims to investigate the existing empirical literature on the factors that affect Cambodia's economy, particularly the impact of credits on the economic growth. It examines the relationship between microfinance institutions (MFIs) and commercial banks (CBs) loans and Gross Domestic Product (GDP) in Cambodia from 2009 to 2018 and analyzes their respective significant impacts on economic growth. This research employed simple and multiple regressions to develop the effects' conceptual models. The results showed that loan supply had a significantly positive relationship with GDP, while 1% increase in MFIs' loan volume led to an increase of 1.30% in GDP and 1% increase in CBs' loan volume led to an increase 0.38% in GDP, with an R-square of 95%. Furthermore, loan supply was found to have a significant positive relationship with GDP per capita, with an R-square of 95%, while \$1 billion increase in MFI loan volume leading to an increase of \$68.95 in GDP per capita and \$1 billion increase in CB loan volume leading to an increase of \$16.11 in GDP per capita. Hence, the study indicated that loan supply had positively contributed to the economic development of Cambodia. The findings of this study contribute not only to assessing the role of credits in stimulating the growth of the Cambodian economy but also to yielding some implications and recommendations for future research, the banking industry, and policymakers.*

**Keywords:** Credits, microfinance institutions (MFIs), commercial banks (CBs), Gross Domestic Product (GDP), and GDP per capita

## 1. Introduction

Cambodia is a developing country located in Southeast Asia. People in this region know it as a small and low-income country, while the Gross Domestic Product (GDP) per capita was only 302.58 dollars in 2000, with a population of 12.16 million (Global Economy, 2021). The economic history of this country was mainly dependent on two main factors: tourist inflow and agriculture. This traditional behavior of economic activities spent Cambodia in a low-income country over the past two decades. In the early 2000s, the government set a priority plan to reduce the poverty in this country. In order to meet this plan, Cambodia first needed to have a stable economy. Controlling the component of the economics sectors such as monetary policy, inflation and promotion of the financial system to support financial private sectors. Moreover, government has also set a strategy of “Financial Sector Blue print for 2001-2010” by promoting foreign direct investment to Cambodia (ADB, 2001). A convenience of conducting financial transaction had become a main attraction to the foreign investors. A significant in changing some traditional economics activities moved from a low-income country to reaching lower middle-income status in 2015, GDP per capita was \$1,192.60 and continued increasing steadily to \$1,512.13 in 2018. The Association of Banks in Cambodia has claimed that "Cambodia is a bank-based economy, n.p" which means the financial institutions, especially commercial banks, are the primary source of funding" (ABC, 2021). Ninety percent of Cambodia's financial 'assets are in the country's banking system. Banking system assets increased by 20.9% in 2017 to approximately \$34.93 billion in 2018, equivalent to 143% of the GDP (Privacy Shield Framework, 2021). Moreover, this sector has been an important sector since 2009, while the total commercial loan to GDP was 24.3%, 47.7%, and 83.5% in 2009, 2013, and 2018, respectively (ADB, 2021).

Since credits concentrated in vital economic sectors such as wholesales and retails (27.5%), agriculture (8.9%), construction (9.2%), real estate activities and owner-occupied housing (17.4%), and other sectors (37.5%) (Privacy Shield Framework, 2021), it demanded that loan plans and actions be taken into account. Hence, specific plans must be designed to meet Cambodia's future demands for loan services. Thus, keeping the above in mind, the present study makes a modest attempt to analyze how the demand for loans impacts the growth rate, with particular reference to its problems and prospects.

The main objectives of this study are to investigate the existing credit trend related to GDP in Cambodia from 2009 to 2018 and to analyze the significant impact of credits on the economic growth in Cambodia.

This study will investigate the existing empirical literature on the factors that push the Cambodian economy while studying the relationship between credits on the economic growth in Cambodia by testing the most recent data from 2009 to 2018. The findings of this study will

not only help us assess whether the role of banks stimulates the growth of the Cambodian economy but will also indicate the direction of loan performance in the economy.

## 2. Literature Review

### *Definitions of key terms*

There are many studies of how loans affect GDP. Some researchers reviewed the effects of loans on GDP by examining different sectors of loans while other researchers examined the effects of performing and non-performing loans on GDP. This study aims to investigate the appropriate term of loan by focusing on the Impact of credits on the economic growth of Cambodia.

Credits is a contractual agreement in which a borrower receives loans now and agrees to repay the lender later —generally with interest (Kenton, 2020). On the other hand, Twin (2020) defined bank credit as the amount of credit available to a business or individual from a banking institution in the form of loans. Bank credit, therefore, is the total amount of money a person or business can borrow from a bank or other financial institutions. It depends on the borrowers' ability to repay the loans and the lenders' total credit amount available to lend (Twin, 2020). Types of bank credit include car loans, personal loans, and mortgages.

Economic growth, in general, is defined as a percentage increase in the total amount of goods and services produced per head of the population over a period of time. Investopedia (2021) has defined economic growth as an increase in the aggregate production of a country's goods and services, compared from one period to another. The aggregate level can be measured by the GDP or the gross national product (GNP). It can be forecasted in a nominal or real (inflation-adjusted) term.

### *Credits and economic growth*

It is essential to know the role of loans in the economic development of Cambodia since the concept of loans has become more widespread in the last few decades. Before that, it had traditionally been a minor subject for a study involving the identification of the causes and implications for banking and financial distress since households were considered trustworthy borrowers or typically had collateral pledged with their borrowing. These enable banks to prevent excessive losses on household lending compared to corporate lending. The concentration of studies and examination of loan performance and its implication for the banking crisis has been put on the corporate sector.

The correlation between loans and economic growth has been a theme in numerous theoretical and empirical studies. Some papers demonstrate the pros and cons of loans on economic growth in Romania, Nigeria, Saudi Arabia, and the Arab world. The conclusion that can be drawn is

that financial development leads to the economic growth when forecasting future economic growth rates or technological change. Moreover, the quality of the financial system is influenced by economic activities.

A study on the implications of credit activities on the economic growth in Romania by Duican and Pop (2015) had to include data pre- and post-crisis. The study observed the history of Romanian business activities before and during the crisis. It was found that, while in crisis, loans played an essential role in this country since the results of the study showed that credit has a significant influence on the evolution of GDP in the eight development regions of Romania, while an increase of one monetary unit in credit would determine an increase of 1.47 monetary units in GDP. Based on the results of the study, banks should continue to finance the economy through credit as it contributes significantly to GDP growth in Romania.

In the same results, a study by Aniekan and Jimoh (2011) on the topic of banking sector credit and economic growth in Nigeria investigated the relationship between banking sector credits and the economic growth in Nigeria over the period 1970–2008, found that the banking sector-credit positively impacted the economic growth over the period covered. Moreover, some studies, such as those by Walter Bagehot (1873) and John Hicks (1969) argued that the financial system played an essential role in leasing capital mobility in England. In 1912, Joseph Schumpeter argued that identifying and funding the entrepreneurs with the best chances of implementing innovative products would encourage banks to innovate technologically. On the other hand, Joan Robinson claimed that the financial system automatically responded to requests from various financial arrangements created by economic development. In addition, Robert Lucas (1988) and Nicholas Stern (1989) do not support the notion that the financial system-economic growth relationship is significant.

Ananzeh (2016) employed time series data with vector autoregressive (VAR) from 1993 to 2014. He investigated the relationship between banking credit and the economic growth in Jordan. Banking credit was divided into five different sectors: bank credit facilities for all sectors, bank credit facilities for the agriculture sector, bank credit facilities for the industry sector, bank credit facilities for the construction sector, and bank credit facilities for the tourism sector. As a result, he found that banking in different sectors played a positive role in the growth of the Jordanian economy.

During the world economic crisis in 2008–2009, there was a study about the credit growth rate in Romania (Tiberiu, 2009). The study investigated the change in credit ratio that had been divided into two main factors. It conducted an analysis to forecast the credit growth rates for both domestic and foreign currencies. This analysis showed that the growth rate of domestic currency decreased from 40% in April 2008 to 8% in April 2009, while the foreign credit rate dropped from 25% in May 2009 to 22% in October 2009. This transaction led Romania to



register a transition from a credit boom to a credit crunch. The study concluded that absent credit activities led a whole country into an economic crisis.

Gaffar and Osman (2014) investigated the relationship between commercial bank credits provided to the private sector and GDP growth in Saudi Arabia using annual data from 1974–2012. Two main variables are the private sector and GDP, while four other variables—commercial bank's deposits, government expenditure, inflation rate, and open economy—are control variables. The study used the autoregressive lag (ARDL) approach, and the elasticity of GDP to the private sector was (0.054) and (0.051) for the long-run and short-run, respectively. This indicated that credit provided by the private banking sector was essential to the economic growth of Saudi Arabia.

In the same way, another study by Ayuba and Zubairu (2015) in Nigeria concluded that banking sector credit had a significant impact on small and medium enterprises in Nigeria. The study revealed that during the high unemployment rate, credit to SMEs played an essential role in the overall success of Nigeria, which was a catalyst for the Nigerian economic growth.

### *Conceptual framework*

The various empirical literature reviews addressed the significant impact of banking credit on economics in different ways. Some focus on credit provided by the private sector, while others estimate the relationship using the individual characteristics of countries with different forms of time series data.

To describe Cambodia's characteristics, with no different data from different regimes, we construct the equation by a simple linear equation with cross-sectional data from 2009 to 2019 using two main variables: banking credit as an independent variable, and GDP indicating Cambodia's economic push as a dependent variable. Firstly, we investigated the existing trend of the volume of loans and GDP per capita from time series data from 2009 to 2018. Secondly, we employed a more advanced econometrics technique with two simple linear equations and multiple regressions.

The first simple linear regression equation is about the impact of credits from Microfinance Institutions (MFIs) to Cambodia's nominal GDP.



Figure 1: The Impact of MFIs' Loan on nominal GDP in Cambodia.

Secondly, we observe linear equation 2, which is about the impact of credits from Commercial Banks (CBs) to Cambodia's nominal GDP.



Figure 2: The Impact of CBs' Loan on nominal GDP in Cambodia.

Thirdly, we mixed those factors into a multiple regression model to ensure that credits from MFIs and Credit from CBs impact Cambodia's nominal GDP.

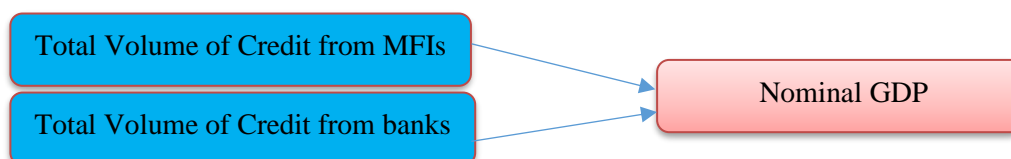

Figure 3 The Impact of CBs and MFIs' Loans on nominal GDP in Cambodia.

Last but not least, we investigate if credits from MFIs and CBs impact Cambodia's GDP per capita.

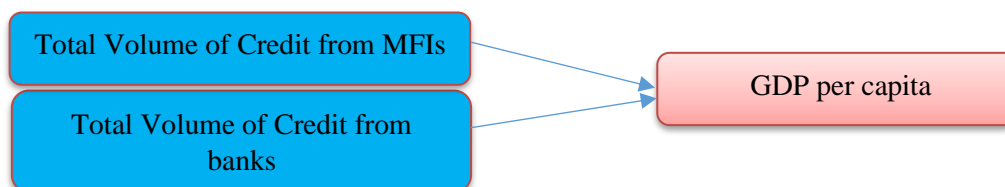

Figure 4: The Impact of CBs and MFIs' Loans on GDP per capita in Cambodia.

### 3. Research Methodology

#### *Research design*

This study used a quantitative method and secondary time series data to test the hypothesis of a correlation between MFI, bank credit, and GDP from 2009 to 2018; MFI and bank credits are considered independent variables (IV), while GDP is the dependent variable (DV).

#### *Types and sources of data*

In order to reach the objective of this study, some statistical techniques were employed. The tables of the increasing volume of loans from 2009 to 2018, a graph of the correlation between the volume of loans and GDP in the same period, a table of independents and the correlation between independent variables and dependent variables were illustrated. The correlation testing, simple regression, and multiple regression were also employed.

There are two steps to investigate this study, firstly, we observed the existing trend of the variables by using a histogram graphic. If the result showed a trend, a second step needed to be done with the correlation of credits toward GDP. Secondly: We examined the impact of MFI loans on GDP, the impact of bank loans on GDP, and the combined impact of the two loan factors on GDP. In order to study this, a secondary time series of macroeconomic data for each of the three indicators were employed; that is, the data on MFI and bank loans were selected from the report of the National Bank of Cambodia, while GDP was from the World Bank. Overall, the study used histograms and secondary data, and, it employed quantitative analysis by using both simple and multiple regressions.

*Statistics tools*

The secondary data collected for the study were processed and tabulated, keeping the study's objectives in mind. The interrelationships among the data form the basis for tabulation. Simple statistical calculations, such as simple and multiple regression and relevant statistical tools, were used in the study to accomplish its objectives. To assess the growth of the tourism sector over the period 2000–2017 in terms of inflows of domestic, international, and total tourists; tourism income; and employment generated in the tourism sector, the following models were used:

**MODEL 1:**  $GDP_t = \alpha + \beta X_t + u_{it}$

Where **Dependent Variables:**

$GDP_t$  = Nominal GDP for the period of 2009 to 2018

**Independent Variable:**

$X_t$  = Volume of MFIs' Loan for the period of 2009 to 2018

$\alpha$  = Constant

$\beta$  = Slope

$u_{it}$  = Error term

**MODEL 2:**  $GDP_t = \lambda + \omega X_t + u_{it}$

Where **Dependent Variable:**

$GDP_t$  = Nominal GDP for the period of 2009 to 2018

**Independent Variable:**

$X_t$  = Volume of CBs' Loan for the period of 2009 to 2018

$\lambda$  = Constant

$\omega$  = Slope

$u_{it}$  = Error term

**MODEL 3:**  $GDP_{it} = \gamma + \nu X_{1t} + \varphi X_{2t} + u_{it}$

Where

**Dependent Variable:**

$GDP_{it}$  = Nominal GDP for the period of 2009 to 2018

**Independent Variable:**

$X_{1t}$  = Volume of MFIs' Loan for the period of 2009 to 2018

$X_{2t}$  = Volume of CBs' Loan for the period of 2009 to 2018

$\gamma$  = Constant

$\nu$  = Slope of MFIs' Loan

$\varphi$  = Slope of CBs' Loan

$u_{it}$  = Error term

**MODEL 4:**  $GDP_{it,P} = \gamma + \nu X_{1t} + \varphi X_{2t} + \varepsilon_{it}$

Where

**Dependent Variable:**

$GDP_{it,P}$  = GDP per capita from the period of 2009 to 2018

**Independent Variable:**

$X_{1t}$  = Volume of MFIs' Loan for the period of 2009 to 2018

$X_{2t}$  = Volume of CBs' Loan for the period of 2009 to 2018

$\gamma$  = Constant

$\nu$  = Slope of MFIs' Loan

$\varphi$  = Slope of CBs' Loan

$\varepsilon_{it}$  = Error term

To understand Cambodia's characteristics, with no different data from different regimes, we constructed the equation by multiple linear equations with time series data from 2009 to 2019 with three main variables: volume of credits from MFI and the volume of credit from Commercial bank as independent variables, and GDP as a dependent variable. Thus, simple regression and multiple regression models were used since they were mentioned in 3.3 Statistics Tools.

#### 4. Results and Discussion

##### *The volume and percentage growth of loans in Cambodia*

Table 1 presents the volume of loans from MFIs and banks in billions of dollars separately and the sum of those two sectors from 2009 to 2018. Further, we investigated the growth rate of Cambodia's total volume of loans.

Table 1: The Growth of the Volume of Loans in Cambodia (2009-2018)

No	Year	The volume of MFIs' Loans (Billion US)	The volume of Banks' Loans (Billion US)	Total Volume of Loans (Billion US)	Increase (%)
1	2009	0.300790046	2.546600909	2.847390955	
2	2010	0.412246893	3.159880294	3.572127187	25.45264222
3	2011	0.638556646	4.356798913	4.995355559	39.84260071
4	2012	0.877483094	5.891790745	6.76927384	35.5113517
5	2013	1.306618242	5.900569177	7.207187419	6.469136712
6	2014	2.016965937	9.530975597	11.54794153	60.22812871
7	2015	3.033033598	5.885952954	8.918986552	-22.76557233
8	2016	3.136361223	14.12613908	17.2625003	93.54777808
9	2017	5.428880134	16.99132103	22.42020116	29.87806384
10	2018	4.289807049	21.08914582	25.37895287	13.1968116
Average Annual Compound Growth Rate (%)					27.51419

Note: i. The total number of Loan is the sum of the number of MFIs and Banks' Loan in a particular

As revealed in Table 1, the total volume of MFIs' and banks' loans in the country reached \$25.37895287 billion in 2018, up from \$2.847390955 billion in 2009. Further, the average annual compound growth rate was estimated to be \$27.51419. The volume of MFIs' loans had continuously increased over the study period (2009–2018), except for one year, 2015. As such, compared to 2014, the percentage change was -22.77. Among the 10 years, the percentage change in the volume of MFIs' loans was the highest (93%) in 2016 and the lowest (6.46%) in 2013.

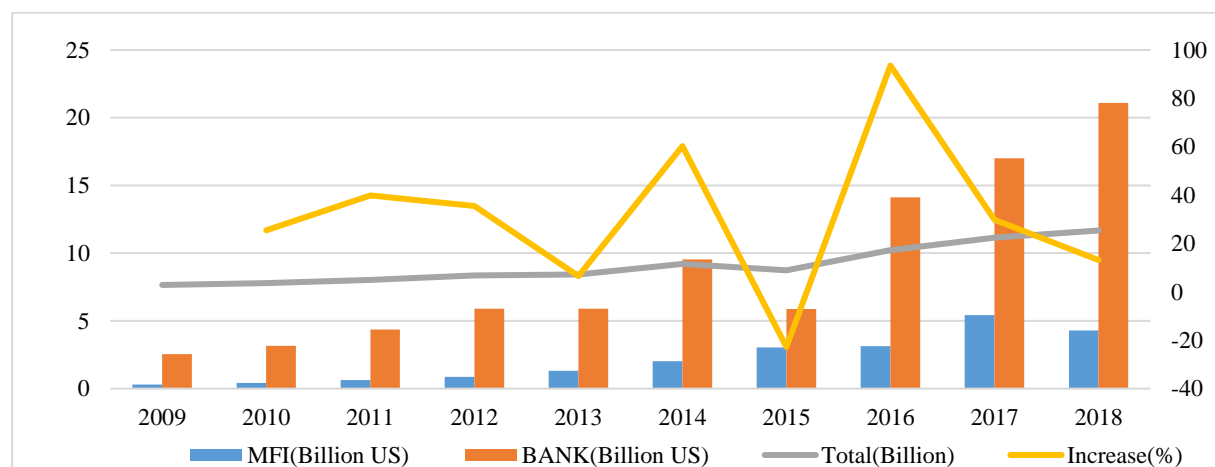

Figure 5: The Growth of Volume and Rate of Loan in Cambodia

The change in volume of both MFIs and banks separately and in total, with their year-over-year change in percentage over the study period, it shown that these factors correlated with each other and their existing trend since 2009 to 2018.

### *Descriptive statistics*

The data in Table 2 illustrates the level of variation for each variable in this study. Table 2 includes the type of variable, minimum, maximum, mean, and standard deviation (SD) analysis within the study period. Since this research employed MFIs and Banks' loans with a ten-year time series, each variable's mean explained each factor's effective level over the ten years. As seen in Table 2, the lowest volume of MFIs is \$0.30 billion, while the highest is \$5.43 billion, with a mean of \$2.14 billion and a standard deviation of 1.76 in the study period. Furthermore, the lowest volume of bank loans is \$2.55 billion, while the highest is 21.09 billion, with a mean of \$8.94 billion and a standard deviation of 6.35 in the same period.

Table 2: Descriptive Analysis

	N	Min (Bil-)	Max (Bil-)	Mean	Std. Deviation
Nominal GDP	10	10.40	24.57	16.5275	4.69152
MFIs' Loan	10	.30	5.43	2.1441	1.76869
CBs' Loan	10	2.55	21.09	8.9479	6.34926
Valid N (listwise)	10				

*The annual existing trend between loan and GDP in Cambodia*

Figure 6 illustrates existing needs with three variables: MFIs' loans, CBs' loans, and nominal GDP. In 2009, their volumes in billions of USD were 0.30, 2.55, and 10.40, respectively. Those volumes increased tremendously in 2018, at 5.43, 21.09, and 24.57, respectively. As a result, while the volume of loans increases, it directly increases the GDP; in other words, there are existing trends among variables.

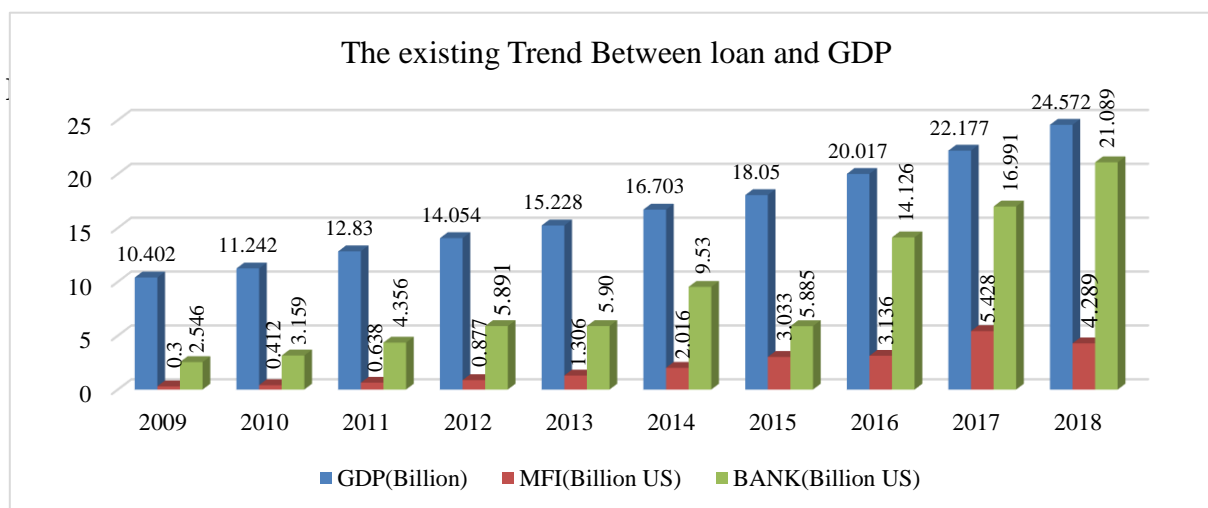

Figure 6: The existing trend of the volume of loans (MFIs) and GDP

*Correlation analysis*

Since the results show an existing trend between bank credit and GDP, another step is to investigate the relationship between those two variables. The growth of banking credit over the period 2009–2018 and the role of credit in the economic development of Cambodia, considering relevant indicators during the study period, have been analyzed quantitatively based on secondary time series data. Finally, quantitative analysis and regression models have been used to analyze the impact of bank credit on economic growth.

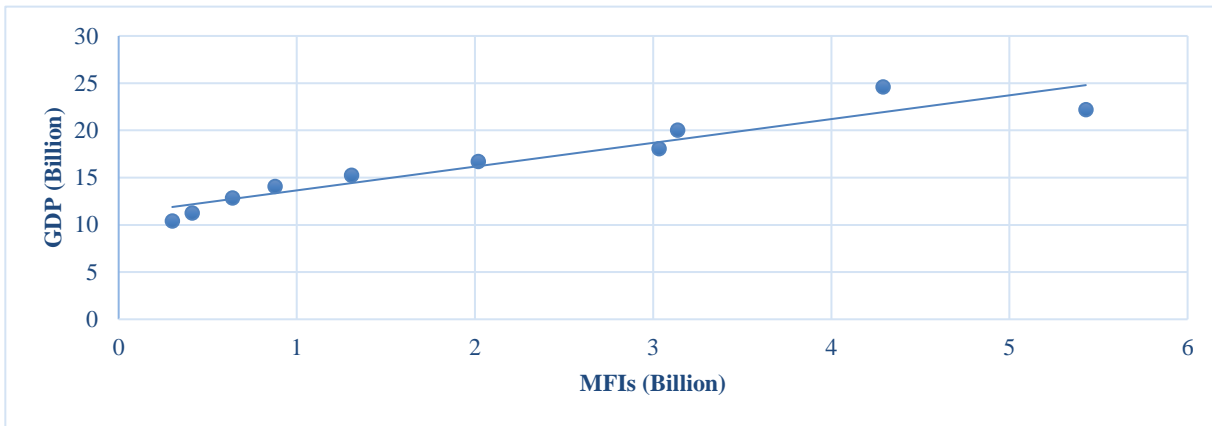

Figure 7: Correlation of volume of loans (MFIs) and GDP by Using Dot Plot.

Figure 7 illustrate the correlation between MFIs’ value of loan and GDP by dot plot with the regression line. We can observe that data are cluster around the regression line with positive a linear relationship between variables, so this fit regression line is taken to study the impact of MFI’s on GDP for the next step.

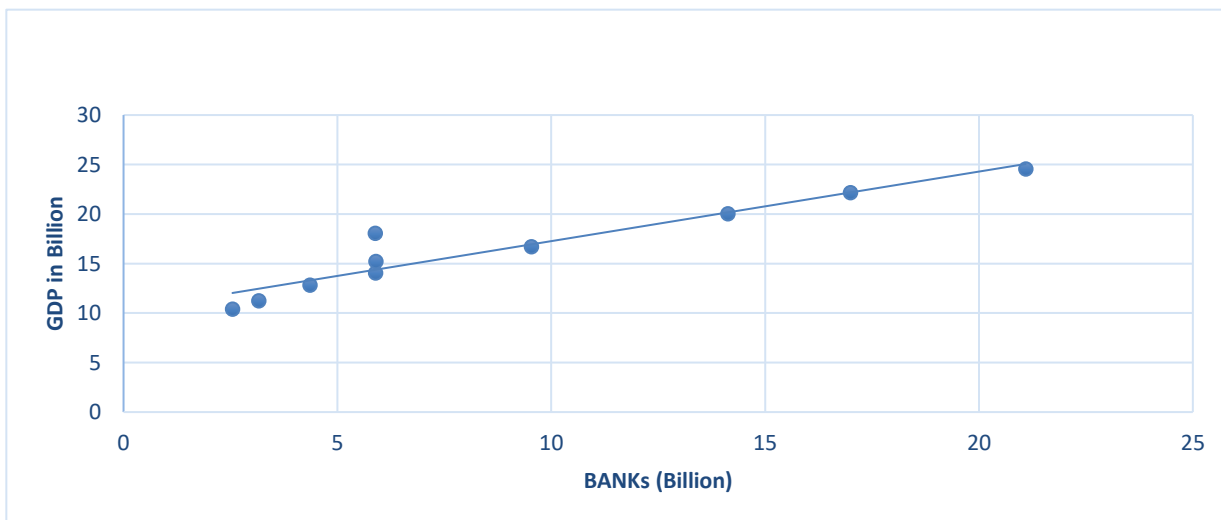

Figure 8: Correlation of volume of loans (Banks) and GDP by Using Dot Plot.

In Figure 8 illustrate the same way as figure 7 with value banks' of loan and GDP by dot plot with the regression line. We can observe that data are cluster around the regression line with positive a linear relationship between variables, so this fit regression line is taken to study the impact of banks' loan on GDP for the next step.

*Test for autocorrelation*

This research employed a time series data, so testing autocorrelation was necessary.

- If the Durbin-Wastson is less than a critical value ( $DW < 2$ ), it is statistically negative relationship to the next value.
- If the Durbin-Wastson is equal to a critical value ( $DW = 2$ ), it is statistically no relationship to the next value.
- If the Durbin-Wastson is equal to a critical value ( $DW > 2$ ), it is statistically positive relationship to the next value.

Table 3: The Negative Impact of MFIs' Loan on GDP

Model 1	R	R Square	Adjusted R Square	Durbin-Watson
1	.949	.900	.887	2.36

Dependent Variable: GDP

Independent Variable : MFIs' Loan

Since the  $DW = 2.36$  is more than 2 (Table 3), it shows that if the value of GDP in t period is higher than the average, so the prediction for next period is also higher than the average.

Table 4: The Positive Impact of Bank's Loan on GDP

Model 2	R	R Square	Adjusted R Square	Durbin-Watson
2	.951	.904	.892	1.760

Dependent Variable: GDP

Independent Variable : CBs' Loan

Since the  $DW = 1.760$  is less than 2 (Table 4), it indicates that if the value GDP in t period is lower than the average, so the next period will be lower than the average.

Table 5: The Positive Impact of Banks and MFIs' Loans on GDP

Model 3	R	R Square	Adjusted R Square	Durbin-Watson
3	.977	.954	.941	1.643

Dependent Variable: GDP

Independent Variable : CBs' Loan, MFIs' Loan

Since the  $DW = 1.643$  is less than 2, it indicates that if the value GDP in t period is lower than the average, so the next period will be lower than the average.



*Pearson’s correlation matrix*

Table 6 shows that all variables are significant and positive correlations between variables: 0.949 of MFIs loans toward GDP, 0.951 of Banks loans toward GDP, and 0.890 of Banks loans to MFIs loans.

Table 6: Pearson’s Correlation Matrix

	Nominal GDP	MFIs’ Loan	CBs’ Loan
Nominal GDP	1		
MFIs’ Loan	0.949**	1	
CBs’ Loan	0.951**	0.890**	1

*Simple and multiple regressions*

First block of regression analysis

The first simple regression analysis was run with MFIs’ loans as the independent variable and nominal GDP as the dependent variable. The R-square value of 0.900 means that the independent variable explained 90.00% of the validity of our dependent variable, which means that only 10.00% of the independent variable is not mentioned in the model. The coefficient, showing the validity of the chosen model, has a value of around 0.949, which is close to 1, indicating that the model chosen is valid. The result of the regression model shown in the equation reflects the correlation between the nominal GDP and the volume of MFIs’ loans, as shown in Table 7:

$$\text{Nominal GDP} = 11.1323 + 2.5163 \text{ MFIs' Loan}$$

This equation illustrates that, if 1% increase in the volume of MFIs’ Loan leads to increase 2.5163% increase in volume of Nominal GDP.

Table 7: Regression of the impact of MFIs’ Loan towards Nominal GDP

Regression 1	Dependent Variable Nominal GDP	$R^2 = 0.900$ Ad. $R^2 = 0.89$	$F = 71.939$ $Sig = 0.00***$
	Independent Variable MFIs’ Loan	Regression Coefficient	‘t’ Value and Sig Level
		2.516	$t = 8.48$ $Sig = 0.00***$

\*\*\*  $p < 0.01$ .

### Second block of regression analysis

The second block of this study is a simple regression analysis run with CBs' loans as the independent variable and nominal GDP as the dependent variable at a significance level. The result of the regression model shown in the equation reflects the correlation between the nominal GDP and the volume of CBs' loans:

$$\text{Nominal GDP} = 10.2405 + 0.7026 \text{ CBs' Loan}$$

The data analysis shows that R-square = 0.9041, which means that independent variables explained 90.41% of the validity of our dependent variable, meaning that only 9.59% of the independent variables are not mentioned in the model. The coefficient, showing the validity of the chosen model, has a value of around 0.90. This value is close to 1, indicating that the chosen model is valid.

Table 8: Regression of CBs' Loan towards Nominal GDP.

Regression 2	Dependent Variable Nominal GDP	$R^2 = 0.90$ Ad. $R^2 = 0.89$	$F = 75.48$ $Sig = 0.000^{***}$
	Independent Variable CBs' Loan	Regression Coefficient	't' Value and Sig Level
		0.70	$t = 8.68$ $Sig = 0.00^{***}$

\*\*\*  $p < 0.01$ .

### Third block of regression analysis

Table 9 shows the third block of this analysis is the multiple regression, in which the MFIs' and CBs' loans are the independent variables, and the nominal GDP is the dependent variable. The result indicates the significance level of both:

The F-statistics value is 62.08 points which is higher than the upper-bound critical value with 0.00\*\*\* significance levels. This means that there is at least one variable impacting the GDP.

Multiple  $R = 0.976$ , measuring the strength of the relationship between MFIs' and CBs' loans (X) with nominal GDP (Y) close to 1, is very high.

$R^2 = 0.9544$ , meaning that independent variables explained 95.44% of our dependent variable's validity, meaning that only 4.56% of the independent variables are mentioned in the model.

The results of the multiple regression model shown in the equation below reflect the correlation between GDP and the volume of Banks' loans:

$$\text{Nominal GDP} = 10.3384 + 1.3058 \text{ MFIs' Loan} + 0.3788 \text{ CBs' Loan}$$

Table 9: Regression of the volume of MFIs and Banks Loan impact GDP

Regression 3	Dependent Variable Nominal GDP	$R^2 = 0.96$ $Ad.R^2 = 0.94$	$F = 77.16$ $Sig = 0.000***$
	Independent Variables MFIs' Loan  CBs' Loan	Regression Coefficients	't' Value and Sig Level
		1.31  0.38	$t = 2.78$ $Sig = 0.02 *$ $t = 2.89$ $Sig = 0.02 *$

\*\*\*  $p < 0.01$ .

The fourth block of regression analysis

The last block of this analysis is the multiple regression, in which the MFIs' and CBs' loans are the independent variables, and the GDP per capita is the dependent variable. The result indicates the significance level of both:

The F-statistics value is 62.08 points which is higher than the upper-bound critical value, with 0.00\*\*\* significance levels. This means that at least one variable impacts Cambodia's GDP per capita.

$R^2 = 0.9544$ , meaning that the independent variable explained 95.44% of the validity of our dependent variable, which means that the model did not mention only 4.56% of the independent variable.

The results of the multiple regression model shown in the equation below reflect the correlation between GDP per capita and the volume of MFI and CB loans:

$$GDP, p = 743.4520 + 71.2337 \text{ MFIs}^{\wedge} \text{ Loan} + 20.4720 \text{ CBs}^{\wedge} \text{ Loan}$$

Table 10: Regression of the Volume of MFIs and Banks Loan Impact GDP per Capita.

Regression 4	Dependent Variable GDP per Capita	$R^2 = 0.95$ $Ad.R^2 = 0.94$	$F = 66.20$ $Sig = 0.00***$
	Independent Variable MFIs' Loan  CBs' Loan	Regression Coefficients	't' Value and Sig Level
		71.23  20.47	$t = 2.65$ $Sig = 0.03$ $t = 2.74$ $Sig = 0.02$

## 5. Conclusion and Implications

### *Summary of findings*

The analysis carried out in this study sheds significant light on the growth in the volume of loans and the impact of those loans on Cambodia's economy. In other words, it discusses the role of loans in the economic development of Cambodia. Based on the availability of data, indicators of loan growth, such as MFIs' and banks' loans over the period 2009–2018, were examined to determine if there is a significant effect of loans from MFIs and loans from banks on the economic growth of Cambodia for the period 2009–2018. As a result, loan supply is found to have a significantly positive relationship with GDP. In contrast, a 1% increase in the volume of loans from MFIs could lead to an increase in real GDP of 1.30 percent, while a 1% increase in bank loans could lead to an increase in real GDP of 0.38% with an R-square of 95%. In addition, loan supply was also found to have a significantly positive relationship with GDP per capita. In contrast, 1 billion dollar increases in the volume of loans from MFIs could lead to an increase of 68.95 dollars in GDP per capita, and 1 billion dollar increases in the volume of bank loans could lead to an increase of 16.11 dollars in GDP per capita with an R-square of 95%. Based on this finding, it can be concluded that loan supply has positively contributed to the economic development of Cambodia.

### *Implications*

The implications of this study will be for future research, as the researchers left behind a model and extended variables. Since the role of loans in Cambodia's economy will not last for this study period (2009–2018), policymakers should develop appropriate policies for loan performance in each institution to protect against loan defaults that may cause risk. These ideas should help policymakers create new models for the actual practice of lending in this society.

This study has also captured the potential components for analyzing the factors that impact GDP and GDP per capita. The study's results have demonstrated a slight concern about loans from MFIs and loans from banks. In other words, although MFIs and banks' loans have positively benefited the national GDP and helped push the economic growth, they cannot avoid indebtedness, especially in rural areas where some institutions raise high-interest rates (Thiel, 2001). To reduce the negative impacts, all relevant banking sector authorities must take a clear strategic plan and well-being action plans to orient benefits by linking with the rest of the direct and indirect economics to decrease non-performing loans.

### *Limitations and future research*

To examine the role of loans in economic development, dependent variables such as GDP per capita and GDP have been considered. The study could have provided better results with more

independent variables. Future researchers may therefore consider taking into account specific areas of loan contribution in some sectors, such as agriculture, real estate, wholesale and retail, owner-occupied housing, and others.

The development of loan services depends on a clear strategic plan that the government and private sector are willing to implement. Cambodia's first principal action plan is ensuring political stability, followed by an improved modern banking system and improvement in interest rate policy. There should be a committee to control loan performance in any banking institution, including both the public and private sectors, to ensure that those institutions follow the instructions of NBC, which will increase loan quality. Furthermore, policymakers and planners should develop appropriate plans and policies to promote loan services to attract more investment and domestic enterprises to start a business in Cambodia. In future research, specific measures, as suggested in the study, should be systematically implemented to increase the time-series data for 20 to 30 years in regression measurement.

## References

- ABC. (2021). *Banking environment*, the association of banks in Cambodia, Retrieved November 08, 2021, <http://www.abc.org.kh/banking-environment>.
- Ananzeh, I. E. N. (2016). Relationship between bank credit and economic growth: Evidence from Jordan. *International Journal of Financial Research*, 7(2), page???. <https://doi.org/10.5430/ijfr.v7n2p53>
- Aniekan, O., & Jimoh, S. (2011). *Banking sector credit and economic growth in Nigeria: An empirical investigation*. CBN Journal of Applied Statistics, The Central Bank of Nigeria.
- Ayuba, B., & Zubairu, M. (2015). *Impact of banking Sector credit on the growth of small and medium enterprises (SMEs) in Nigeria*. Journal of Resources Development and Management Journal, 15, 1–9.
- Chun, BJ. ET.AL. (2001). Finacail sector blueprint for 2001-2010. Asean Development Bank. <https://www.adborg/sites/default/files/publication/27921/ca-blueprint-2001>
- Duican (Moiesescu), E. R., & Pop, A. (2015). The implications of credit activity on economic growth in romania. *Procedia Economics and Finance*, 30(15), 195–201. [https://doi.org/10.1016/s2212-5671\(15\)01286-1](https://doi.org/10.1016/s2212-5671(15)01286-1)
- Gaffar, E., & Osman, A. (2014). The impact of private sector credit on Saudi Arabia economic growth (GDP): An Econometrics Model Using (ARDL) Approach to Cointegration. *American International Journal of Social Science*, 3(6), 109–117.
- Global Economy (2020). *Cambodia: GDP per capita, constant dollars*, The Global Economy, Retrieved August 24, 2021, <[https://www.theglobaleconomy.com/Cambodia/GDP\\_per\\_capita\\_constant\\_dollars/](https://www.theglobaleconomy.com/Cambodia/GDP_per_capita_constant_dollars/)>
- Hicks, J. (1969). *Journal of Money, credit and banking*, Conference of University Professors (Aug. 1969), pp. 307–317. <https://www.jstor.org/stable/1991183>
- Lucas, R. (1988). *Journal of Monetary Economics* 22 (1988) 3–42. North-Holland. Feb. 1988. Privacy Shield Framework 2021, *Cambodia - Banking Systems*, Privacy Shield Framework, Retrieved July 28, 2021, <https://www.privacyshield.gov/article?id=Cambodia-banking-systems>>.
- Stern, N. (1989). The Economics of Development: A Survey. *The Economic Journal*, Vol. 99, No. 397 (Sep. 1989), pp. 597–685. <http://www.jstor.org/stable/2233764>
- Thiel, M. (2001). Finance and economic growth – a review of theory and the available evidence. 158.
- Tiberiu, C. (2009). *Forecasting Credit Growth Rate in Romania: from credit boom to credit crunch?* Forecasting Credit Growth Rate in Romania: From Credit Boom To Credit Crunch?, 5(1), 62–75.
- Twin, A. (2020). *Bank Credit: Definition, how it works, types, and Examples*, Retrieved August 24, 2021, <<https://www.investopedia.com/terms/b/bank-credit.asp>>.

## Factors Influencing Customer Usage of QR Code Payment: A Case Study of ACLEDA Institute of Business Students

**Bun Khem, Lundy Sem, Phirum Norng, Dina Lim, and Soren Chea**

Corresponding Author. Email: bunbama79@gmail.com  
ACLEDA INSTITUTE OF BUSINESS, Phnom Penh, Cambodia

### ABSTRACT

*The study attempts to determine influential factors of QR code payment adoption in financial industry in Cambodia. The study employs quantitative approach with the total sample size of 231, using a correlational design. The combined factors of the DeLone & McLean IS Success Model and TAM model are used to find the customers' intention to adopt QR code payment. The study has shown that perceived information quality, perceived usefulness, perceived ease of use, and attitude are statistically significant at .000, .003, .000, and .012, respectively, whereas perceived system quality is not statistically significant. For a summary of the model fitness, the study can predict 82% in variance of behavioral intention (BI) to use QR code payment influenced by the independent variables.*

**Keywords:** QR code payment, information quality, system quality, perceived usefulness, perceived ease of use, attitude, and behavioral intention

## 1. Introduction

### *Background of the study*

The industrial revolutions (IR) have affected people's lifestyles through technological advancements (Taj & Jhanjhi, 2022). Industry 5.0 envisions the mass production with zero waste, minimal cost, and maximal accuracy (Zeb et al., 2022). Notably, one of the themes for Industry 5.0 is human-robot co-working (Demir et al., 2019).

Ganesan and Gopalsamy (2022) have asserted that blockchain technology has affected the financial world, and digital marketing drastically. In this regard, the financial technology known as Fintech has emerged through the combination of technology and finance in order to support financial activities. According to Nijjer et al. (2022), "Fintech is enhancing the banking industry through several channels and financial inclusion may include the provision of financial services to underserved populations with limited access to traditional financing channels." Fintech is currently expanding and bringing a new era and competing classic financial methods (Haris Haxhimehmeti & Adrian Besimi, 2020, Ahmi et al., 2020).

### *Problem statement*

As part of Fintech, mobile payment system involves players, namely: customer, merchant, issuing bank, acquiring bank and micropayments systems such as software architectures, security, mobile payment methods, mobile acceptance of the system, QR code method to complete a payment, and component interaction (Haris Haxhimehmeti & Adrian Besimi, 2020). Fintech which performs cashless payment and convenient financial services is considered limited, whereas the blockchain technology, a breakthrough for digital financial transactions, helps save time and money, to ensure security for money transfer and to promote cashless payment (Mishra, 2022). Digital payments have changed people's financial behaviors in Asian countries and the expansion of the internet network and the intensification of gadget functions have fostered digital payment systems in mobile payments, internet banking, QR Codes, and electronic payments (Susanto et al., 2022). The issue arises as to what pushes ACLEDA Institute of Business students to adopt the financial transactions by using QR Code payment.

### *Research objectives*

The study focuses on banking industries' financial services and transactions by using mobile payment systems:

- To examine factors influencing customer intentional usage of QR Code payment
- To find out the relationship of influential factors with QR Code payment



### *Research question*

To reach the objective, the researchers employed research questions as follow:

- What are the factors influencing the use and acceptance of QR Code payment?
- How is the relationship of the influential factors with QR Code payment?

### *Significance of the study*

The study provides insight into the trends influencing banking clients' adoption of Fintech for any routine mobile payment with smartphones and smart devices. Meanwhile, the study has validated the research model concerning finance and technology development in the Cambodian context in order to develop better understanding about the smart ecosystem for the new industrial revolution 5.0 vision.

## **2. Literature Review**

### *Overview of payment systems and Quick Response (QR Code)*

#### Payment systems

According to the National Bank of Cambodia (NBC) (2020), payment systems are important for the financial infrastructure of the country, contributing to the economic development of the nation with efficient payment, the exchange of money for goods, services, and financial assets. The safe and efficient feature enables authorities to manage systemic risk and monetary policy implementation. Banking industry of the private sector providing the digital and electronic payment services, digital network for access to finance, households, small and medium enterprises is considered crucial to fuel the economic growth for sustainability, convenience, affordability, fairness, and safety features with relevant stakeholders without discriminating the types of institutions (NBC, 2020).

The white paper entitled “The Next Generation Payment System” of the NBC wrote, “digital wallets allow a user to simply wave or tap their smart phone to complete a transaction (NBC, 2019). The commercial banks provide credit remittance via branch, ATM, Internet, PC, and mobile. The major commercial banks like ACLEDA are providing credit remittance services via ATM, internet or mobile banking, and the volume of USD payment transactions, which is larger than those of KHR payment transactions” (NBC, 2020).

The banks provide diversified products and services as cards service, digital service, funds transfer service, trade finance service, and other cash management facilities besides loans and deposits (ACLEDA Bank Plc., 2022). The digital services such as ACLEDA Mobile,

ACLEDA internet banking, ATM machines, and ACLEDA POS are well known among financial services clients (ACLEDA Bank Plc., 2022). ACLEDA Mobile is a FinTech application running on smart phone, which enables customers to perform their banking transactions anywhere and anytime has become so popular from day to day and with this application, payments can be made from all types of cards and QR from all banks (ACLEDA Bank Plc., 2021).



Figure 1: ACLEDA Mobile app (ACLEDA Bank Plc., 2021) and NBC's Bakong Apps

### Quick Response (QR Code)

The banking sector in Cambodia promotes safe and efficient payment system for economic agents. The Safe and efficient payment systems are crucial for the financial system and economy as a whole (NBC, 2023). The monetary and payment system authority of the NBC has developed Bakong App to promote the use of local currency and electronic payment in Cambodia (NBC, 2020). The Bakong function is a convenient feature for real-time fund transfer, instant payment transaction, interconnectedness and interoperability openness to all payment service providers and the adoption of QR code payment. It is widely used by Cambodian younger population as a modern payment system via QR code (NBC, 2020). A Quick Response (QR Code) utilizes a smartphone camera for payment (Susanto et al., 2022), a payment for products, goods or services between two parties, consumers and merchants (Nseir Sana et al., 2013). The QR Code payment is a financial inclusion that ensures the ease of access, availability, and usage of formal financial system, the equality of opportunities to access financial services inclusively to all people of a nation (Loo, 2019). According to the NBC (2020, p. 20), "Financial Inclusion is a primary agenda of the NBC. One of the effective measures to promote financial inclusion is to ensure a cashless society where transactions could be performed digitally, and money transfer/mobile banking is accessible and affordable to every citizen."

Mobile media are channels for digital marketers and advertisers because of their potential to support one-to-one, one-to-many and mass communication at a reasonable price and effective

manner; mobile marketing ensures customer engagement with a brand, user-generated content, and mobile commerce (Watson et al., 2013). Firms are using QR code initiatives in their marketing strategies (Shin et al., 2012).



Figure 2: QR Code (AIB, 2023)

### *Toward a conceptual framework*

#### Perceived information quality, system quality and interactivity

DeLone & McLean Success Model introduced the framework for measuring the performance of information systems (DeLone & McLean, 2004). DeLone and McLean’s (1992) model suggests that both system usage and user satisfaction be affected by these two factors: information quality, system quality (Bokhari, 2005). DeLone & McLean (1992) reviewed the multiple dimensional components of IS success and identified six components of IS success: system quality, information quality, use, user satisfaction, individual impact, and organizational impact (Petter et al., 2008), as shown in figure 3.

Information quality captures the user perceived value of the output produced by a system and measured by information accuracy, relevance, timeliness and completeness. The perceived information quality perceived as the “cognitive beliefs about the favorable or unfavorable characteristics of the accuracy, completeness, relevance and reliability of the information derived from QR codes” (Shin et al., 2012).

The system quality is about the measurement of the functionality of a system, the usability, availability, reliability and response time (Shin et al., 2012). The system quality of QR codes is perceived “as the degree to which individuals perceive that the connection between a mobile device and the QR code is satisfaction in terms of transfer speed and reliability” (Shin et al., 2012).

The QR code interactivity include responsiveness, user control and connectedness, perceived personalization, real time interactions, playfulness are the critical components (Shin et al., 2012). Perceived credibility is “the extent to which an individual believes that the use of service technology will have no security or privacy threats” (Kongarchapatara & Rodjanatara, 2018) and the highly interactive characteristics of QR code use, and user intention towards technology acceptance and adoption are key success in advertising.

H1: Perceived information quality positively influences on customer intention to use QR code payment.

H2: Perceived system quality positively influences on customer intention to use QR code payment.

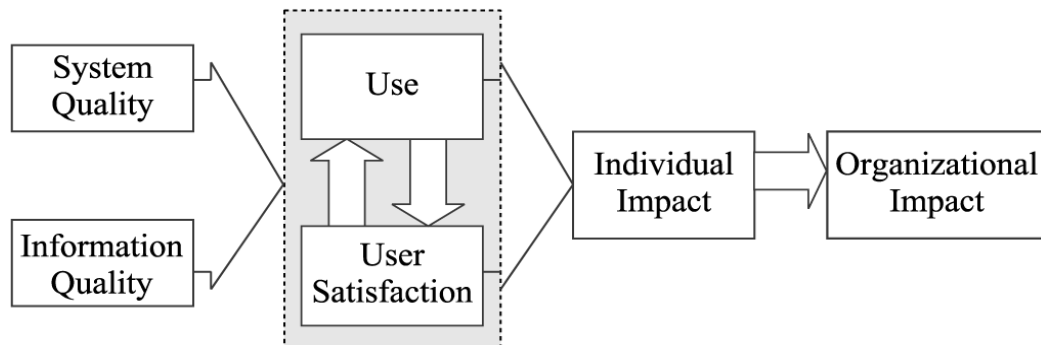

**Source:** Adapted from DeLone and McLean (1992)

Figure 3: The DeLone & McLean Success Model

The researchers in the area of IS Success developed and validated system quality, information quality, use, and user satisfaction; and modified the “Use” with “Usefulness of Davis” model (Petter et al., 2008). The perceived usefulness is about the “user believes the technology/particular system will improve his/ her performance, and job-fit-how the capabilities of a system enhance an individual’s job performance (Venkatesh et al., 2003). Petter et al. (2008) describe the components of the D&M model as the following: (1) User satisfaction is about “users’ level of satisfaction with reports, websites, and support services; (2) the net benefit is about “the extent to which IS are contributing to the success of individuals, groups, organizations, industries, and nations”; (3) user information satisfaction (UIS) contain items related to system quality, information quality, and service quality, rather than only measuring overall user satisfaction with the system”.

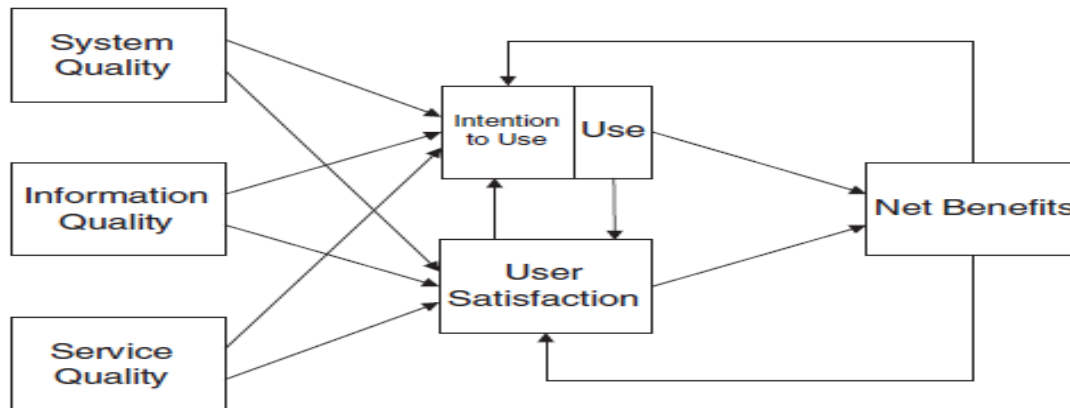

Figure 4: Updated Delone and Mclean is success model

*Perceived usefulness, ease of use, attitude and behavioral intention*

The constructs, namely perceived usefulness, ease of use, attitude and behavioral intention, proposed by (Venkatesh & Bala, 2008; Venkatesh et al., 2003), are called Technology Acceptance Model (TAM). The perceived usefulness and perceived ease of use could be affected by external variables (Liu et al., 2010). Any new technology needs to be perceived as being useful and easy to use in order for it to be accepted (Ozkaya et al., 2015). The perceived ease of use is “the belief that using the technology will be free of effort and using an innovation is perceived as being difficult to use” (Venkatesh et al., 2003). The theory of reasoned action (TRA model) stated that an attitude is about “an individual's positive or negative feelings (evaluative affect) about performing the target behavior” (Venkatesh et al., 2003). Attitude is “an individual’s positive and negative feelings about the performing the target behaviors (Ventakesh et al., 2003). The previous papers mentioned attitude as “a critical influential predictor of behavioral intention towards banking products and services” (Suebtimrat & Vonguai, 2021). Behavioral Intention refers to the probability of the users’ willingness to make mobile payment (Ventakesh et al., 2003; Suebtimrat & Vonguai, 2021).

Previous studies found that perceived usefulness has a positive and significant effect on the intention to adopt mobile banking (Em et al., 2021). Also, another study found perceived ease of use influence intention mobile banking adoption through the attitudes (Norng, 2022). Finally, several studies found attitudes influence mobile payment or mobile banking (Em et al., 2021; Norng, 2022; Yang et al., 2021)

- H3: Perceived usefulness has a positive effect on customer intention to use QR code payment
- H4: Perceived ease of use has a positive effect on customer intention to use QR code payment
- H5: Attitude has positive effects on customer intention to use QR code payment

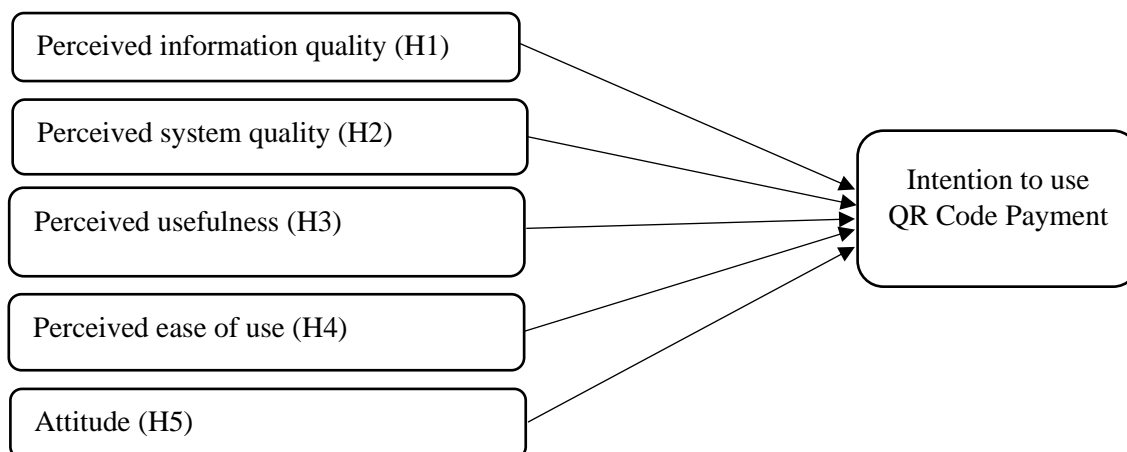

Figure 5: Proposed Research Model

This paper modified service quality of the updated D&M IS Model with Perceived interactivity and unhidden usefulness from information quality and ease of use from system quality of the D&M model.

### 3. Research Methods

#### *Research design*

The paper employed quantitative research approach, using a correlational study design to examine the relationship among the independent, moderating and dependent variables. The descriptive and inferential statistics were used to find out the relationships of the proposed constructs. The research instrument was adapted from validated similar literature contexts (Hanif et al., 2018).

#### *Research area*

The study was conducted in Phnom Penh, specifically at the ACLEDA Institute of Business (AIB), to find out the factors influencing the usage of QR code payment among AIB students.

#### *Population and sample*

The AIB students were selected as the accessible population in the study due to the common uses of the QR payments among the students. The population size of the QR code payment users is unknown and the sample size of the study from the whole population was calculated at the 95 per cent confidence, accounting for the error of margin at 5 per cent based on the sample size of 231. Green (1991) and Tabanick and Fidell (2013) show the required sample formula as follows, “ $N \geq 50 + 8m$ ” and where “ $m$ ” is the number of IVs; that is sufficient for testing the multiple correlation and “ $N \geq 104 + m$  for testing individual predictors”. In practicality, the required

sample size depends on a number of issues, including the desired power, alpha level, number of predictors, and expected effect sizes (Tabachnick & Fidell, 2013; Knofczynski & Mundfrom, 2008).

*Research participants*

The table 1 shows the demographic information of the 231 research participants, comprised of males 13.9% and females 86.1% with the age range from under 20 years to above 30 years. The participants use mobile apps for payments with the following mobile apps: ACLEDA, Bakong, ABA, Wing, and others along the QR code use frequency.

Table 1: Demographics

Respondents' demographic	Category (n=231)	Frequency	Percentage
Gender	Male	32	13.9
	Female	199	86.1
Age	Under 20 years old	108	46.8
	between 21 to25 years old	120	51.9
	between 26 to 30 years old	1	.4
	Others	2	.9
Mobile Apps	ACLEDA Mobile Apps	149	64.5
	BAKONG Apps	69	29.9
	ABA Mobile Apps	3	1.3
	Wing Bank App	1	.4
	Others	9	3.9
QR Code Use Frequency	Once a week	28	12.1
	Twice a week	21	9.1
	Twice a month	8	3.5
	Every day	75	32.5
	When necessary	99	42.9

*Research tools and measurements of constructs*

Survey questionnaire, using Google form, was developed based on the measured items adapted from literature studies. The items were carefully reworded to fit QR Code adoption context in Cambodia. The Google form link was sent to the respondents via G-mail and telegram for the data collection. The instrument was self-administered, using a seven-point Likert scale, ranging from strongly disagree to strongly agree.

Table 2: Summary of Measurement Construct

Variables	Items	Sources
Perceived information quality	PIQ1: I think that QR codes provide a variety of information and services PIQ2: I think that the services and information I can get from QR codes are valuable. PIQ3: QR codes provide the information and services that I need in a timely fashion.	Delone and Mclean (1992), Lee et al. (2002)
Perceived system quality	PSQ1: I think that QR codes provide very reliable service PSQ2: I think that the speed of QR codes is sufficient. PSQ3: I think that QR codes are secure to use. PSQ4: I find that QR code are safe and efficient.	Parasuraman et al. (1988), Shin(2009) (NBC, 2020)
Perceived usefulness	PU1: I evaluate QR codes as useful. PU2: I evaluate QR code service as practical. PU3: I evaluate QR codes as functional. PU4. The QR mobile payment system is a useful mode of payment PU5: QR mobile payment systems allow quick use and flexibility.	Davis (1989) Bhattacharjee (2001)
Perceived ease of use	PEU1: I find using QR codes easy. PEU2: It is easy to learn to use the QR mobile payment system. PEU3: It is easy to follow all the steps to use the QR mobile payment system. PEU4: It is easy to interact with the QR mobile payment system PEU5: Overall, QR codes are easy and convenient.	(Davis (1989) Bhattacharjee (2001), Davis(1989), Taylor and Todd (1995) Venkatesh and Davis (2000),
Attitude	The use of QR mobile payments is a good idea. The use of QR mobile payments is convenient. The use of QR mobile payments is beneficial. The use of QR mobile payments is interesting.	Yang and Yoo (2004), Schierz Schilke, and Wirtz (2010)
Behavioral Intention	BI1: I think I will use QR codes in the future. BI2: I recommend that others use QR codes. BI 3: I intend to continue using QR codes in the future. BI 4: I intend to use a QR mobile payment system when the opportunity arises. BI 5: I am open to using a QR mobile payment system in the near future	Davis (1989), Shin (2009)

*The level of agreement analysis*

The pilot test for reliability was used to test the measured items. Armstrong (1987) asserts that the higher the score, the more important the variable is. The Seven-Likert- scale point applied



to measure the factors, which influence the consumers’ perception QR Code Payment in Phnom Penh.

Table 3: The Level of Agreement Analysis

No	Likert Scale	Acceptable scored rank	Source
1	Strongly Disagree	1 - 1.84	(Armstrong, 1987)
2	Disagree	1.84 - 2.70	
3	Somewhat disagree	2.7 - 3.56	
4	Neutral	3.56 - 4.42	
5	Somewhat Agree	4.42 - 5.28	
6	Agree	5.28 - 6.14	
7	Strongly Agree	6.14 - 7.00	

Table 4: Reliability Statistics

Variables	Items	Pilot Cronbach’s Alpha (n=50)
Perceived information quality (PIQ)	3	0.882
Perceived system quality (PSQ)	4	0.849
Perceived usefulness (PU)	5	0.916
Perceived ease of use (PEU)	5	0.936
Attitude (ATT)	4	0.940
Behavioral Intention (BI)	5	0.957

The Cronbach's Alpha, the estimator of test reliability that suite for use in single applications of a test, typically in a cross-sectional design (Forero, 2014), ranged from the lowest 0.849 to the highest 0.957 for the test reliability.

#### *Data collection*

A cross-sectional descriptive study conducted in 2023 with the AIB students who are using Payment App, through the use of Google form as a means to collect data from the selected participants.

#### *Data analysis*

The survey questionnaire was downloaded from Google form and encoded in Spreadsheet. The data were then transformed into numerical data. The Statistical Package for the Social Sciences

(SPSS) version 23 of IBM was used to analyze data with descriptive statistics, using means, standard deviation of each factor, and referential statistic for correlation and regression. The set of relationships between one or more independent variables, either continuous or discrete, and one or more dependent variables, either continuous or discrete, can be either factors or measured variables (Tabachnick & Fidell, 2013). The regression analysis was employed to examine the relationship between a dependent variable and several independent variables and to determine how strong relationships between dependent variable and independent variables are.

*Ethical consideration*

Ethically, literature, authors, publishers, data sources, sampling and data analysis in academic research are seriously taken into account in this study to ensure the research integrity through the whole research process. There was a consent from the research committee before the study was conducted in order to ensure that the study was conducted in a professional and ethical manner. Meanwhile, the study was in line with the AIB vision, missions and values.

**4. Results and Discussions**

*Correlation analysis*

The results show the correlation among constructs, namely the lowest value .720 of the correlation between perceived system quality and perceived information quality and the highest value .915 of the correlation between the attitude and the perceived ease of use .915 as illustrated in table 5. Tabachnick and Fidell, (2017) have asserted that correlation is used when the intent is simply to investigate the relationship between the dependent variables and independent variables.

Table 5: Multiple Correlations Matrix

Items	PIQ	PSQ	PU	PEU	ATT	BI
Perceived information quality	1					
Perceived system quality	.720**	1				
Perceived usefulness	.804**	.786**	1			
Perceived ease of use	.773**	.831**	.869**	1		
Attitude	.769**	.751**	.832**	.915**	1	
Behavioral Intention	.797**	.775**	.845**	.877**	.851**	1
N	231	231	231	231	231	231

\*\* . Correlation is significant at the 0.01 level (2-tailed).

\* . Correlation is significant at the 0.05 level (2-tailed).

The table 6 shows that the model is significant for the study at .000, which indicates that at least one independent variable among the predictors (perceived information quality, perceived system quality, perceived usefulness, perceived ease of use, attitude) affects the dependent variable (behavioral intention) with  $F(5, 225) = 204.61$ ,  $p < .001$  along with  $r = .905$ ;  $R^2 = .820$ , which indicates that the model can predict 82% in variance of behavioral intention (BI).

Table 6: Analysis of Variance

ANOVA <sup>a</sup>					
Model	Sum of Squares	Df	Mean Square	F	Sig.
1 Regression	225.814	5	45.163	204.618	.000 <sup>b</sup>
Residual	49.662	225	.221		
Total	275.476	230			

Dependent Variable: Behavioral Intention

Predictors: (Constant), Perceived information quality, perceived system quality, perceived usefulness, Perceived ease of use, Attitude

Table 7: Coefficients analysis

Constructs	Unstandardized Coefficients		Standardized Coefficients	Sig.
	B	S. E	Beta	
(Constant)	.128	.181		.482
Perceived information quality	.194	.051	.192	.000
Perceived system quality	.070	.054	.069	.193
Perceived usefulness	.194	.066	.190	.003
Perceived ease of use	.355	.093	.336	.000
Attitude	.188	.074	.186	.012

Dependent Variable: Behavioral Intention

The table of coefficients indicates the perceived information quality of  $\beta = .192$  with p-value .000, perceived system quality with  $\beta = .069$  and the p-value .193; perceived usefulness with  $\beta = .190$  and P-value .003; perceived ease of use with  $\beta = .336$  and p-value .000\*\*; and the attitude of  $\beta = .186$  with p-value .012.

### *Hypothesis testing result*

The behavioral intention (BI) was regressed by predicting variables: perceived information quality, perceived system quality, perceived usefulness, perceived ease of use, and attitude (Table 7).

The table 7 shows that perceived information quality, the perceived ease of use, perceived usefulness, and the attitude are statistically significant while the perceived system quality was not significant at p-value greater than 0.05.

### *Discussion*

The result shows that there are some influential factors, namely perceived information quality, perceived usefulness, perceived ease of use; and attitude play important role to push customer acceptance of QR Code payment. This study corresponds to the previous literature by (Delone & Mclean, 2003, Petter et al., 2008, Shin et al., 2012) that perceived information quality has p-value .000; perceived ease of use has p-value .000\*\*, all be positive result. Furtherly, perceived usefulness with p-value .003, and the attitude with p-value .012, this also indicates positive result,

## **5. Conclusion and Implication**

### *Conclusion*

The study of banking industries' financial services and transactions by using mobile payment systems has determined some influential factors on customer usage of QR Code payment. Firstly, the research concern "what are the factors influencing the use and acceptance of QR Code payment?" The influential factors are perceived information quality, perceived usefulness, and perceived ease of use. They play most crucial impact on QR Code payment of customers. The secondly, "how is the relationship of the influential factors with QR Code payment?" The perceived information quality correlates with behavioral intention .797, perceived usefulness with behavioral intention. 845, perceived ease of use with behavioral intention .877; and attitude with behavioral intention (QR Code payment acceptance). So, this correlation is significant at the 0.01 level (2-tailed test).

### *Limitation and recommendations for future research*

The study employed a quantitative approach with the total sample size of 231 who use QR code payment. It applied the D&M IS Success model with the integrated TAM model with only the data from one higher education institution. The future work should deal with larger sample heterogeneity to gain more insight for the generalization of the findings. Researchers recommend  $p < .001$  and R Square = .820, which indicates that the model can predict 82% in variance of behavioral intention (BI) of the QR Code payment users in the Phnom Penh capital.

## References

- ACLEDA Bank Plc. (2021). ACLEDA Bank - Annual Report 2021. Annual Report.
- ACLEDA Bank Plc. (2022). Digital Services. [https://www.acledabank.com.kh/kh/eng/ps\\_ebanking](https://www.acledabank.com.kh/kh/eng/ps_ebanking)
- Ahmi, A., Tapa, A., & Hamzah, A. H. (2020). Mapping of Financial Technology (FinTech) Research: A Bibliometric Analysis. *International Journal of Advanced Science and Technology*, 29(8), 379–392.
- AIB. (2023). *ACLEDA Institute of Business - Cambodia*. <https://www.acleda-aib.edu.kh/tc/eng/>
- Bokhari, R. H. (2005). The relationship between system usage and user satisfaction: A meta-analysis. *Journal of Enterprise Information Management*, 18(2), 211–234. <https://doi.org/10.1108/17410390510579927>
- Brooks, G. P., & Barcikowski, R. S. (2012). The PEAR method for sample sizes in multiple linear regression. *Multiple Linear Regression Viewpoints*, 38(2), 1–16.
- Delone, W. H., & Mclean, E. R. (2003). The DeLone and McLean Model of Information Systems Success: A Ten-Year Update. In *Information Systems Research, Journal of Management Information Systems* (Vol. 19, Issue 4).
- DeLone, W. H., & McLean, E. R. (2004). Measuring e-commerce success: Applying the DeLone and McLean Information Systems Success Model. *International Journal of Electronic Commerce*, 9(1), 31–47. <https://doi.org/10.1080/10864415.2004.11044317>
- Demir, K. A., Döven, G., & Sezen, B. (2019). Industry 5.0 and Human-Robot Co-working. *Procedia Computer Science*, 158, 688–695. <https://doi.org/10.1016/j.procs.2019.09.104>
- Em, S., Norng, S., & Thab, C. (2021). The Analysis of Technology Acceptance Model on the Study of Consumer Attitudes toward the Intention to Adopt Mobile Banking App in Cambodia. *AIB Research Series, Volume 1*, 74–86. <http://acleda-aib.edu.kh/tc/eng/business-news-20210302.pdf>
- Forero, C. G. (2014). Cronbach's Alpha. In A. C. Michalos (Ed.), *Encyclopedia of Quality of Life and Well-Being Research* (pp. 1357–1359). Springer Netherlands. [https://doi.org/10.1007/978-94-007-0753-5\\_622](https://doi.org/10.1007/978-94-007-0753-5_622)
- Ganesan, S., & Gopalsamy, S. (2022). Marketing 5.0: Digital Marketing Trends Analysis. In *International Journal of Advanced Research and Emerging Trends (JARET)* (Vol. 3, Issue 1). www.JARET.IN
- Hanif, A., Jamal, F. Q., & Imran, M. (2018). Extending the technology acceptance model for use of e-learning systems by digital learners. *IEEE Access*, 6(c), 73395–73404. <https://doi.org/10.1109/ACCESS.2018.2881384>
- Haris Haxhimehmeti, & Adrian Besimi. (2020). *Prototyping Micropayment Mobile Platform using QR Codes*.
- Knofczynski, G. T., & Mundfrom, D. (2008). Sample Sizes when Using Multiple Linear Regression for Prediction. *Educational and Psychological Measurement*, 68(3), 431–442.

- Loo, M. K. L. (2019). Enhancing Financial Inclusion in ASEAN: Identifying the Best Growth Markets for Fintech. *Journal of Risk and Financial Management*, 12(4), 181. <https://doi.org/10.3390/jrfm12040181>
- NBC. (2019). *Technology Risk-Management-Guidelines*.
- Nijjer, S., Sood, K., Grima, S., Rupeika-Apoga, R., & Varma, P. (2022). Thematic Analysis of Financial Technology (Fintech) Influence on the Banking Industry. *Risks*, 10, 186. <https://doi.org/10.3390/risks>
- Nseir Sana, Nael Hirzallah, & Musbah Aqel. (2013). *A Secure Mobile Payment System using QR Code*. IEEE.
- Norng, S. (2022). Factors Influencing Mobile Banking Adoption in Cambodia: The Structuring of TAM, DIT, and Trust with TPB. *Asian Journal of Business Research Volume*, 12(3).
- Petter, S., DeLone, W., & McLean, E. (2008a). Measuring information systems success: Models, dimensions, measures, and interrelationships. *European Journal of Information Systems*, 17(3), 236–263. <https://doi.org/10.1057/ejis.2008.15>
- Petter, S., DeLone, W., & McLean, E. (2008b). Measuring information systems success: Models, dimensions, measures, and interrelationships. *European Journal of Information Systems*, 17(3), 236–263. <https://doi.org/10.1057/ejis.2008.15>
- Priyanka Mishra, et al. (2022). Sustainable Smart City to Society 5.0 State of the Art and Research Challenges. *SOUTH AFRICAN INSTITUTE OF ELECTRICAL ENGINEERS*.
- Project Bakong. (2020). *Next Generation Payment System Next Generation Payment System*.
- Shin, D. H., Jung, J., & Chang, B. H. (2012a). The psychology behind QR codes: User experience perspective. *Computers in Human Behavior*, 28(4), 1417–1426. <https://doi.org/10.1016/j.chb.2012.03.004>
- Shin, D. H., Jung, J., & Chang, B. H. (2012b). The psychology behind QR codes: User experience perspective. *Computers in Human Behavior*, 28(4), 1417–1426. <https://doi.org/10.1016/j.chb.2012.03.004>
- Susanto, E., Solikin, I., & Purnomo, B. S. (2022). A REVIEW OF DIGITAL PAYMENT ADOPTION IN ASIA. *Advanced International Journal of Business, Entrepreneurship and SMEs*, 4(11), 01–15. <https://doi.org/10.35631/aijbes.411001>
- Tabachnick, B. G., & Fidell, L. S. (2013). *Using Multivariate Statistics*. Pearson.
- Tabanick, B. G., & Fidell, L. S. (2013). *Using Multivariate Statistics Edition?*
- Taj, I., & Jhanjhi, N. Z. (2022). Towards Industrial Revolution 5.0 and Explainable Artificial Intelligence: Challenges and Opportunities. *International Journal of Computing and Digital Systems*, 12(1), 285–310. <https://doi.org/10.12785/ijcds/120124>
- Venkatesh, V., & Bala, H. (2008). Technology Acceptance Model 3 and a Research Agenda on Interventions. In *The Author Journal Compilation C* (Vol. 39). Decision Sciences Institute.
- Venkatesh, V., Morris, M. G., Davis, G. B., & Davis, F. D. (2003). *MIS Quarterly*.

- Watson, C., McCarthy, J., & Rowley, J. (2013). Consumer attitudes towards mobile marketing in the smart phone era. *International Journal of Information Management*, 33(5), 840–849. <https://doi.org/10.1016/j.ijinfomgt.2013.06.004>
- Yang, S., Norng, S., & Thab, C. (2021). Consumer’s Attitudes toward the Intention to Adopt Mobile Payment System: A Study on Mobile Application of ABA Bankin Cambodia. AIB Research Series, 1, 1–19. <http://acleda-aib.edu.kh/tc/eng/business-news-20210302.pdf>
- Zeb, S., Mahmood, A., Khowaja, S. A., Dev, K., Hassan, S. A., Qureshi, N. M. F., Gidlund, M., & Bellavista, P. (2022). *Industry 5.0 is Coming: A Survey on Intelligent NextG Wireless Networks as Technological Enablers*. <http://arxiv.org/abs/2205.09084>

## **Factors Influencing Customer Loyalty of Coffee Shops in Phnom Penh City**

**Sinit To, Phirum Norng, Raingsey Keo, Vanda Vong, and Soren Chea**

Corresponding Author. Email: [sinithbu@gmail.com](mailto:sinithbu@gmail.com)  
ACLEDA INSTITUTE OF BUSINESS, Phnom Penh, Cambodia

### **ABSTRACT**

*The study aims to identify the impact of product quality, service quality, brand innovation, and physical environment on customer loyalty in coffee shops in Phnom Penh City. The study adopted a correlational study of a quantitative method by collecting data from 370 coffee drinkers through a survey questionnaire. The study found that product quality, brand innovation, and physical environment positively affected customer loyalty to the coffee shops, while service quality was not statistically significant.*

**Keywords:** Product quality, Service quality, Brand innovation, Physical environment



## 1. Introduction

### *Background of the study*

Over the last decade, drinking coffee has become popular among Cambodian people in their daily lifestyles. Thus, the number of coffee shops has mushroomed in recent years. This has resulted in the demand for product and service quality from the customers to the business owners. The trend also provides benefits for the coffee shops in Phnom Penh, which must be addressed to equate the appropriate strategies and business growth for the present and the future. The market is expanding every year, showing the increase of trendy consumers bolstered by breakfast, lunch, and dinner times, following the Western lifestyle. Notably, there has been a high demand among young people, including students, workers and tourists in the city. Over the recent decades, coffee shops have become great places where friends, families, and business partners gather for social talks, work discussions, and business deals. Coffee consumption has been surging in urban areas even along the urban streets in Cambodia, especially in Phnom Penh city.

### *Problem statement*

Amron (2018) explained the characterization of product quality and its effect on customer loyalty. To (2018) and Mony and Be (n.d.) discussed service quality and its effect on customers' impact of using the service. Thapa (2010) explained that product innovation is one of the marketing incentives that can encourage people to use the service again. Soonthorn-Opas (n.d.) and To (2018) discussed how the physical environment influences customers' decision to buy a specific product now and in the future. However, the current research on business in Cambodia is relatively scant, and there is currently a knowledge gap concerned with consumer behaviors. This has necessitated a research study to shed light on how product quality, service quality, brand innovation, and customer loyalty affect customer loyalty.

### *Research objective*

The objective of this study is to find out the factors influencing customer loyalty, using coffee shop service by adopting the SERVQUAL Model such as the product quality, service quality, brand innovation, and physical environment.

### *Research question*

The study raises a research question as follows:

What factors influence customer loyalty to the coffee shops in Phnom Penh city?

### *Significance of the study*

The study would contribute to the current or new business owners and supervisors who are willing to run and manage the coffee shop in Phnom Penh city, Cambodia. Moreover, it would enable the new researchers to find out the applicability of the model in the research study in the Cambodian business context. Last but not least, the findings would contribute to the advancement of knowledge in the field based on SERVQUAL Model employed in the Cambodian context.

## **2. Literature Review**

### *Product quality*

Dalólio, et al. (2017) defined product quality as the ability of a product to perform its function. It can be resilience, reliability, precision, simple operation, improvement, and other valuable attributes. From the marketing perspective, product quality denotes the ability of a product to satisfy the requirements of the consumers and can be measured by the buyers' understanding (Seth et al., 2005) and a personal feeling on product quality. Perceived quality is extremely significant in maintaining existing customers and is a comparative concept of situational, comparative, and individual attributes (Keller, 1993). Many studies are investigating the relationship between product quality and purchase decisions. Baruk and Iwanicka (2015) examined the effect of product quality on purchase decisions in Poland. The results have indicated a strong correlation between product quality and buying decisions. This result of the study is the same as that of the study conducted by (MONY & BE, n.d.) and (Díez et al., 2014) in Spain. Amron (2018) stated that business owners can transform product quality into a possible strategy weapon to increase quality better than competitors by consistently providing better products and services to satisfy consumers' needs and preferences for product quality.

### *Service quality*

Service quality includes Reliability, Assurance, Tangibles, Empathy, and Responsiveness (RATER) (Abeyvance, 2013). The RATER framework evolved from the SERVQUAL study psychologists. Finn et al. (1991) refers reliability to as an ability to deliver the service a customer expects when the customer expects. Reliable service is regular, accurate, timely, and consistent. Unsurprisingly, it is the most important of all the service dimensions. It determines consumers' satisfaction and also affects business success, especially in the food and beverage industry (Shekarchizadeh et al., 2011). Wong (2004) found that service quality might positively affect satisfaction, which affects consumers' loyalty and relationship. The service environment refers to the judgment about the general environment of the store by consumers (Lehtinen & Lehtinen, 1991) and it can be measured by surrounding conditions, design, and community factors.

### *Brand innovation*

Brand Innovation is the setting of design innovation for product performance innovation. According to Nguyen et al. (2015) and Berry et al. (1994), brand innovation presents a given level of product and service quality when consumer innovation is used, meaning that brand innovation represents the creation of something new by an organization that satisfies its customers and increases its market share. Because the purpose of innovation is to bring something unique, competitors do not have and caused a positive and good customer experience toward the provider (Naveed et al., 2012; Berry et al., 1994). The innovation used for strategies oriented toward customer loyalty can gain market potential that increases the market share of the coffee shop.

### *Physical environment*

According to Chang (2000), in the physical environment, the term “services” refers to all of the objective physical factors that can be controlled by the firm to enhance (or constrain) employee and customer action". The effects of physical surroundings on service quality have also been studied by Wall and Berry (2007) who stated that the physical environment could influence customer expectations of service quality and service (loyalty) because clients need tangible clues to create a picture to estimate the quality. The physical surrounding is one of the most critical marketing tools for business owners.

### *Customer loyalty*

Customer loyalty is a state of mind in which the customer's needs, wants, and expectations throughout the product, service, innovation, or environment life (Wall & Berry, 2007), resulting in future repurchase loyalty. (To, 2018) has shown that customers are also more inclined to recommend it to their friends and family. According to Habte et al. (2016), many researchers define customer loyalty as the impression of reward received by the customer after making the sacrifice of purchasing a product (Minarti & Segoro, 2014; Amron, 2018). The findings are corroborated by a few studies, the results of which indicated that decoration, color, background music, and cleaning and grooming of service providers (Ryu & Han, 2010). Wall and Berry (2007) have found that physical environment affects customers' expectations of service quality and loyalty, which is similar to Ryu and Han (2010) who have found that a good physical environment can generate consumers' positive emotions, intention, satisfaction, and loyalty to a restaurant.

*Research model*

This study examines the impact of product quality, service quality, brand innovation, and physical environment on the customer loyalty of the coffee shops in Phnom Penh. Thus, the four components are conceptualized as a model in the study to find out their impact on customer loyalty as shown in figure 1.

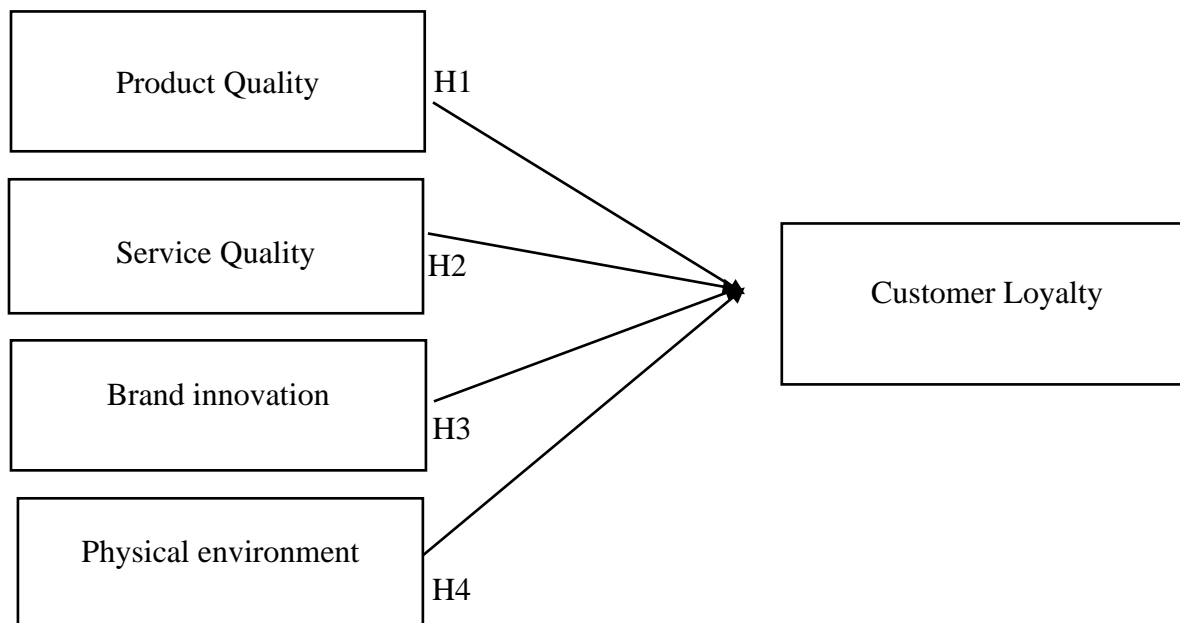

Figure 1: The current study’s Conceptual framework

*Research hypotheses*

Based on the conceptual model, the following hypotheses have been proposed.

- H1: Product quality positively affects customer loyalty.
- H2: Service quality positively affects customer loyalty.
- H3: Brand innovation positively affects customer loyalty.
- H4: Physical environment positively affects customer loyalty.

**3. Research Methodology**

*Research design*

The study employed a quantitative design, using questionnaires as a tool for the data collection. The tool was constructed based on the related theories and was approved by the experts.

*Sampling*

The research samples were selected from the people who had direct experiences of consuming coffee at the different coffee shops in Phnom Penh, the capital city of Cambodia.

The samples were selected by means of a probability sampling method, specifically the cluster sampling method. With the sample size of 370, the respondents were selected to answer questionnaires based on the of product quality, service quality, brand innovation, and physical environment on the customer loyalty. According to Green (1991),  $N > 50 + 8m$  (where  $m$  is the number of IVs) for testing the multiple correlation and  $N > 104 + m$  for testing individual predictors (Tabanick & Fidell, 2013). The questionnaires were distributed to the respondents, and the completed questionnaires were collected on the sites immediately after the respondents' completion.

*Research tool*

The research tool was developed with the focus on product quality, service quality, brand innovation, and physical environment, and the relationship between influence and customer loyalty concerning using services at coffee shops in Phnom Penh. The respondents were asked to follow the given instructions and answer the questions without bias. Notably, all the items were measured using a five-point Likert scale, 5= Strongly agree, 4= Agree, 3= Natural 2= Disagree, 1= Strongly Disagree.

*The level of agreement analysis*

The pilot test for reliability was used to test the measured items, according to Armstrong (1987). The five Likert- scale point applied to measure the factors, which has a significant positive effect on customer loyalty in the capital city.

Table 1: The Level of Agreement Analysis

No	Likert Scale	Acceptable scored rank	Source
1	Strongly Disagree	1.00 -1.85	
2	Disagree	1.86- 2.71	
3	Neutral	2.71- 3.56	(Armstrong, 1987)
4	Agree	3.57- 4.42	
5	Strongly Agree	4.43- 5.00	

Table 2: Reliability Statistics

Variables	Items	Pilot Cronbach's Alpha (n=50)
Product quality	4	.784
Service quality	5	.868
Brand innovation	5	.840
Physical environment	5	.723
Customer loyalty	5	.682

The result of the internal consistency test for reliability called Cronbach's alpha, the estimator of test reliability suitable for use in single applications of a test, typically in cross-sectional designs (Forero, 2014) ranged from the lowest .682 to the highest .868. According to Nunnally (1994), the value (.682) is acceptable.

#### *Data analysis*

The data were analyzed by demographic analysis, using descriptive statistics: mean, standard deviation, frequency, and percentage. Multiple Regression techniques were used to examine the relationship between independent variables and dependent Variables, using Statistical Package for the Social Science (SPSS) software. The purpose of conducting this relationship analysis was to find out the degree of influence of the four independent variables on the dependent Variable.

## **4. Research Results**

### *Demographic information*

Demographic data, including gender, age, income, educational background, and occupation, time for the opening, frequency of visiting, amount of coffee drinking a day, attraction of using coffee shop service, time spent using service, were measured, using percentage ratio and frequency counting.

As shown in table 3, the most respondents were female, accounting for 56.20%. The respondents' ages were between 17 to 25 years, accounting for 58.40%, most of whom were company employees (31.40%). For educational background, the result has shown that approximately 63% were bachelor's degree holders. The respondents who had income between 180\$-250\$ accounted for 30.30% while 30.30 % also earned more than 500\$. Last but not least, almost 24.9 % visit coffee shops every day.

Table 3: Demographic information of Respondents

Items	Category	Frequency	Percentage
Gender	Female	208	56.20%
	Male	162	43.80%
Age	17- 25 years old	216	58.40%
	Between 25 to 30	26	7.00%
	Between 30 to 35	20	5.40%
	More than 30 years old	108	29.20%
Occupation	Banking/Financial	88	23.80%
	Company Employee	116	31.40%
	Students	90	24.30%
	Business Owner	14	3.80%
Education	Other	62	16.80%
	Below bachelor's degree	8	2.20%
	Bachelor's Degree	234	63.20%
	Master's Degree	94	25.40%
Income: (USD)	Doctoral Degree	34	9.20%
	Less than \$180-\$250	112	30.30%
	\$250-\$300	42	11.40%
	\$300-\$350	64	17.30%
	\$400-\$450	40	10.80%
Which is the most appropriate time for the coffee shop to open?	More than \$500	112	30.30%
	0:500am	32	8.60%
	0:600am	154	41.60%
	0:700am	110	29.70%
	0:800am	44	11.90%
	0:900am	4	1.10%
What frequency do you visit coffee shops?	Other____	26	7.00%
	Daily or almost	92	24.90%
	Time a week	36	9.70%
	2-3 times a week	88	12.40%
	3-4 times a week	46	10.30%

### Correlation analysis

The correlation level and validity between all the constructs in this research were tested. The researchers brought 5 constructs into testing. According to Pearson (1926), the correlation values range from -1 to +1 and were calculated to explore the association between variables. This means the closer the number in each variable reaches nearly +1, the stronger correlations are, which means the more positive relationship between two variables is (Pearson, 1926).

Table 4 shows that all variables are significantly correlated at 0.01 (2-tailed). The results also showed the favorable and positive correlations between variables with the lowest 0.427 of PE toward BI and highest 0.589 of SQ toward PE

Table 4: Correlation of construct

	1-PQ	2-SQ	3-BI	4-PE	5-CL
1-Product Quality (PQ)	1				
2-Serviced Quality (SQ)	0.562	1			
3-Brand Innovation (BI)	0.512**	0.563**	1		
4-Physical environment (PE)	0.552**	0.589**	0.427**	1	
5-Customer loyalty (CL)	0.521**	0.445**	0.496**	0.499**	1

\*\*\* correlation is significant at the 0.01 level (2-tailed).

### Regression analysis

The regression analysis result in SPSS is as follows:

The ANOVA output was examined to check whether the proposed Model was feasible. Therefore, the analysis of variance in table 5 indicated that product quality, service quality, brand innovation, and physical environment has positive influenced on customer loyalty. The result showed that the overall Model was significant (F = 56.924, P value = 0.000).

Table 5: ANOVA

Model		Sum of Squares	df	Mean Square	F	Sig.
1	Regression	120.912	4	30.228	56.924	.000 <sup>b</sup>
	Residual	193.824	365	.531		
	Total	314.736	369			



Table 6 shows that three hypotheses: product quality affected by customer loyalty (Beta= .245) at .000; brand Innovation affected by customer loyalty (Beta= .245) at .000; physical Environment (Beta= .256) at .000 and Beta= .243 at .000 on customer loyalty. The study has found that one hypothesis about service quality was not supported on customer loyalty.

Table 6: Regression Analysis

IV	DV	B	Std. Error	Beta	T	Sig.
Product Quality	Customer loyalty	0.221	0.049	0.245	4.495	0.000
Service Quality	Customer loyalty	0.02	0.058	0.02	0.349	0.728
Brand Innovation	Customer loyalty	0.287	0.058	0.256	4.923	0.000
Physical Environment	Customer loyalty	0.216	0.048	0.243	4.503	0.000

### *Hypotheses testing*

Table 7 indicate that three hypotheses were supported as below:

Table 7: Hypotheses result

Hypothesis	P-value	Significant
H1. Product quality positively affects customer loyalty	0.000	Supported
H2. Service quality positively affects customer loyalty	0.728	Not Supported
H3. Brand innovation positively affects customer loyalty	0.000	Supported
H4. Physical Environment positively affects customer loyalty	0.000	Supported

## **5. Conclusion and recommendations**

### *Conclusion*

This paper examined the factors considered influential on customer loyalty in business area, Phnom Penh, the capital city of Cambodia. The factors include product quality, service quality, brand innovation, and physical environment, which are perceived to be influential on the customers' purchase decision. The study has shown that coffee is viewed as the daily need of residents, especially young people and teenagers who are employees in both the public and private sectors and entrepreneurs. Overall, this paper found that service quality, hypothesis 2, has no relationship with customer loyalty to coffee shops. Despite this, the study has shown that product quality, hypothesis 1, has a positive relationship with customer loyalty to coffee shops. This finding was related to the explanation of Parasurman, Valarie Zeeithaml, and Leonard (1988). As in hypothesis 4, physical environment is shown to have a significant positive

relationship with customer loyalty to the coffee shops. The finding was consistent with the study of Loloyd, (2002) and Auld Siegrist (2002). Lastly, in hypothesis 3, brand innovation is found to have a positive relationship with customer loyalty supported by a Nemati, Khan and Iftekhar (2010) and Hausam (1995).

#### *Recommendations for business*

The study found that customer loyalty at the coffee shop has been positively influenced by product quality, brand innovation and physical environment. The customer loyalty has been determined since customers drink the coffee daily, from cup to cup, from time to time, and from day-to-day. Therefore, the study provides the following recommendations.

For the physical environment, business owners shall locate the coffee shop along highway, inbound and outbound. They shall focus on a cleanlier and tidier of the shop, an environmentally friendly atmosphere, an open space of the shop, enough seats inside and outside the shop, and a good decoration inside the shop.

Secondly, researchers found that product quality is importance on customer's loyalty. It is significant in allocating the business operating budget appropriately. Therefore, there is some consideration about product quality in terms of the strong delicious, the varieties of coffee taste, and the appropriate packages design. It is plausible to explain.

Thirdly, researchers found that brand innovation business influence customer loyalty. Coffee owners shall build the brand of the coffee shop by increasing ambient condition, music, furniture, ambient, equipment, décor, lighting, spatial layout, and coffee maker.

Finally, even though the service quality does not influence customer loyalty, the coffee shop owners shall focus on the speed of service, the appropriate time of closing and operating the shop, and staff's polite manner.

#### *Recommendation for future research*

The sample size of the research study is small and focuses on Phnom Penh city only. Thus, the study recommends further research to enlarge the sample size, especially the respondents who live at the provinces to make the results more generalizable in Cambodia. Furthermore, future research should further examine why service quality does not influence customer loyalty.

## References

- Abeysvance, A. D. U. (2013). Effectiveness of quality management system in CoTs. *Tertiary and Vocational Education Commission Research Cell*.
- Amron, A. (2018). The Influence of Brand Image, Brand Trust, Product Quality, and Price on the Consumer's Buying Decision of MPV Cars. *European Scientific Journal, ESJ, 14*(13), 228. <https://doi.org/10.19044/esj.2018.v14n13p228>
- Baruk, A. I., & Iwanicka, A. (2015). Polish final purchasers' expectations towards the features of dairy product packaging in the context of buying decisions. *British Food Journal*.
- Berry, L. L., Parasuraman, A., & Zeithaml, V. A. (1994). Improving service quality in America: lessons learned. *Academy of Management Perspectives, 8*(2), 32–45.
- Brady, M. K., & Cronin Jr, J. J. (2001). Customer orientation: Effects on customer service perceptions and outcome behaviors. *Journal of Service Research, 3*(3), 241–251.
- Chang, K. (2000). The impact of perceived physical environments on customers' satisfaction and return intentions. *Journal of Professional Services Marketing, 21*(2), 75–85.
- Díez, P., Sánchez, A., Gamella, M., Martínez-Ruíz, P., Aznar, E., De La Torre, C., ... & Pingarrón, J. M. (2014). Toward the design of smart delivery systems controlled by integrated enzyme-based biocomputing ensembles. *Journal of the American Chemical Society, 136*(25), 9116-9123.
- Dalólio, F. S., da Silva, J. N., de Oliveira, A. C. C., Tinôco, I. de F. F., Barbosa, R. C., de Oliveira Resende, M., Albino, L. F. T., & Coelho, S. T. (2017). Poultry litter as biomass energy: A review and future perspectives. *Renewable and Sustainable Energy Reviews, 76*, 941–949.
- Finn, D. W., & others. (1991). An evaluation of the SERVQUAL scales in a retailing setting. *ACR North American Advances*.
- Habte, G., Hwang, I. M., Kim, J. S., Hong, J. H., Hong, Y. S., Choi, J. Y., Nho, E. Y., Jamila, N., Khan, N., & Kim, K. S. (2016). Elemental profiling and geographical differentiation of Ethiopian coffee samples through inductively coupled plasma-optical emission spectroscopy (ICP-OES), ICP-mass spectrometry (ICP-MS) and direct mercury analyzer (DMA). *Food Chemistry, 212*, 512–520.
- Lehtinen, U., & Lehtinen, J. R. (1991). Two approaches to service quality dimensions. *Service Industries Journal, 11*(3), 287–303.
- Minarti, S. N., & Segoro, W. (2014). The influence of customer satisfaction, switching cost and trusts in a brand on customer loyalty--The survey on student as IM3 users in Depok, Indonesia. *Procedia-Social and Behavioral Sciences, 143*, 1015–1019.
- MONY, A. V., & BE, B. B. (n.d.). *FACTORS INFLUENCING CUSTOMER BEHAVIORS TO PURCHASE COFFEE AT CAFÉ AMAZON IN PHNOM PENH*.
- Naveed, T., Akhtar, I., & Cheema, K. U. R. (2012). *The impact of innovation on customer satisfaction and brand loyalty: A study of the students of Faisalabad*.

- Nguyen, B., Yu, X., Melewar, T. C., & Chen, J. (2015). Brand innovation and social media: Knowledge acquisition from social media, market orientation, and the moderating role of social media strategic capability. *Industrial Marketing Management*, 51, 11–25.
- Shekarchizadeh, A., Rasli, A., & Hon-Tat, H. (2011). SERVQUAL in Malaysian universities: perspectives of international students. *Business Process Management Journal*.
- Thapa, L. B. (2010). *Tourism Promotion and Marketing by Nepal Tourism Board*. Faculty of Management.
- To, S. (2018). *Factors Influencing Cambodian's Customer Loyalty in Using the Service at Coffee Shops in Phnom Penh, Cambodia*.
- Wall, E. A., & Berry, L. L. (2007). The combined effects of the physical environment and employee behavior on customer perception of restaurant service quality. *Cornell Hotel and Restaurant Administration Quarterly*, 48(1), 59–69.
- Wong, A. (2004). The role of emotional satisfaction in service encounters. *Managing Service Quality: An International Journal*, 14(5), 365–376.

## An Empirical Test of the Efficiency of the Asset Pricing Model for Cambodia Securities Exchange (CSX)

Chinho Sam<sup>1</sup>, Pisith Hok<sup>2</sup>, Sovitu Sam<sup>2</sup>, Sethvannak Sam<sup>3</sup>, Channa Lim<sup>3</sup>

Corresponding Author. Email: hok.pisith@acleda-aib.edu.kh

<sup>1</sup> Pannasastra University of Cambodia, Phnom Penh, Cambodia

<sup>2</sup> ACLEDA INSTITUTE OF BUSINESS, Phnom Penh, Cambodia

<sup>3</sup> Non-Banking Financial Services Authority, Phnom Penh, Cambodia

### ABSTRACT

*The capital asset pricing model (CAPM) is a model used to expect a return on risky assets. The model is a linear relationship between the expected return of risky assets to its market risk premium and the beta risk of the asset. This study examined the model's efficiency in the expected return of Phnom Penh Autonomous Port (PPAP) and Port Autonomous Sihanoukville (PAS) stock returns in Cambodia Securities Exchange (CSX). Daily and monthly stock prices of these two assets were collected from CSX's official website. The yearly return has been computed using the model to compare with the actual return of these assets to test the model's efficiency. As a result, the model was always undervaluation to apply to compute the return of PAP in five years from August 2017 to August 2022. For PPAP, applying CAPM to estimate asset return showed that there were undervaluation from 2017 to 2021, and over in 2016, and nine months in 2022. The study concluded that CAPM was inappropriate for CSX to estimate PPAP and PAP costs of capital (stock returns) since these two assets were not strongly related to the CSX index (coefficient of correlation was 0.582 for PPAP and 0.776 for PAP).*

**Keywords:** Cambodia Securities Exchange (CSX), Capital Asset Pricing Model (CAPM), Phnom Penh Autonomous Port (PPAP), Port Autonomous Sihanoukville (PAS)

## 1. Introduction

The Capital Asset Pricing Model is helpful to apply for companies' investment valuations and is a tool for appraising investment (Fabinu, Makinde & Folorunso, 2017). It has been widely considered by investors in the world's financial markets to estimate both the cost of equity and the weighted average cost of capital for firms (Nel, 2011; Rosi, 2016). The model can estimate the expected return on the market as a whole and individual security if the security beta is related to the market portfolio (Ross, Westerfield, Jaffe, & Jordan, 2016). It explains the tradeoff between risk and return of assets in financial markets. From an academic perspective, CAPM, developed by Sharp (1964) and Lintner (1965), is considered a powerful tool for measuring risk and return in financial markets (Berk & DeMarzo, 2020; Coffie, 2012; Rosi, 2016; Wang, 2016), even though it is subject to test for real business cycle effect of using it (Rossvoll, 2013). Those mentioned above indicate the crucial role of CAPM in academic and actual practice in financial markets. This model is essential for analyzing securities, portfolio risk, and return. To the efficiency of the CAPM, the moving average and weighted moving average are used to compare the model's accuracy.

Cambodia Securities Exchange, established in 2011 (CSX, 2022), has 17 listed companies, including nine equity and eight debt-listed companies (CSX, 2022). Trading is conducted every working day from 8:00 am to 3:00 pm. The stock price and volume of each securities trading fluctuated daily (CSX, 2022), leading to the production of the market's index. Some methods (models) are used to forecast future stock prices, and CAPM is one of them needed to make assumptions when using it (Benninga, 2008; Berk & DeMarzo, 2020; Ross, Westerfield, Jaffe, & Jordan, 2016). Rosi (2016) mentioned that there are some assumptions about using CAPM. However, it is still widely used for estimating the cost of capital for firms and evaluating the portfolios' performance. CAPM is a helpful tool for estimating the cost of capital for firms and the returns that investors require in investing in a company's assets.

On the other hand, Coffie (2012) has argued that substantial evidence of the benefits of volatility as an augmenting factor in CAPM is used to explain asset returns in Africa and other emerging markets with similar economic characteristics. It is because a pricing model that includes both market risk premium and volatility risk premium significantly captures patterns of returns. The other study by Zhao (2014) mentioned that the CAPM of Sharpe (1964) and Lintner (1965) presents a single-period simple linear relationship between the securities' expected return and its market risk. Nevertheless, much empirical evidence suggests that the traditional CAPM model has deficiencies. Since this model is still widely used by investors and in academic education, our study focuses on the efficiency of the Capital Asset Pricing Model in Cambodian Stock Markets. The paper examined two state-owned companies: Phnom Penh Autonomous Port (PPAP) and Port Autonomous Sihanoukville (PAS).

The study's main objective was to examine CAPM's efficiency in the Cambodian Securities Exchange. To achieve the study's objective, we focus on

- Comparing the actual asset return with an expected return by using CAPM;
- Comparing the error of the model to errors of using moving average and weighed moving average with the same assets;
- Testing the accuracy of each asset;
- Comparing the errors of valuated assets in the study.

## 2. Literature Review

Stock markets were established centuries ago (Beattie, 2022; Hwang, 2021;; Zhou & Liu, 2018). The common objectives of investors are safety, income, and growth (Chen, 2022a; Reilly, Brown, Hedges & Chang, 2010). Chen (2022a) has mentioned that an investment in stock markets shows that safety, income, and growth objectives are mutually exclusive.

According to Reilly, Brown, and Leeds (2019), the Capital Asset Pricing Model was developed by Sharpe (1964), along with Lintner (1965) and Mossin (1966), and the model described the relationship between risk and expected return of risky assets (Bodie, Kane, & Marcus, 2021; Zhou & Liu, 2018). The model was developed after Markowitz's modern portfolio theory in the 1950s. In the 1960s, CAPM was developed during the foundation theory of decision-making in capital markets (Peroil, 2004).

According to Xiao et al. (2019), an empirical test of the effectiveness of CAPM. There are some assumptions to using CAPM, such as the following:

- First, investors are referred to as business entities. That is, under the same risk level, they choose securities with higher returns, while, at the same level of return, they choose securities with lower risk.
- Second, given the number of assets in the capital market, all assets can be completely subdivided, and assets are fully liquid, marketable, and decentralized.
- Third, the main factors affecting investment decisions are the expected rate of return and risk.
- Fourth, all investors have the same view on the probability of the distribution of securities returns, so there is only one efficiency boundary in the market.
- Fifth, all investors can get complete market information on time and free of charge. They have the same expected value for the expected rate of return, the standard deviation, and the covariance between securities.

- Sixth, there is no inflation, the discount rate remains unchanged, and there are no tax and transaction costs when buying and selling securities.

Berk et al. (2020) mentioned that the CAPM model is based on solid assumptions because some assumptions do not fully describe investors' behavior. The model is a content of risk-free rate, beta risk is the degree of volatility or systematic risk of a security or portfolio to the market as a whole (Kenton, 2022), and market premium and expected return is a linear relationship with its beta as the below formula, due to average market return has been higher than the average risk-free rate in the long run, is probably positive. Thus, the formula implies that the expected return on securities is positively related to its beta. The formula can be illustrated by assuming a few exceptional cases (Ross et al., 2016):

$$r_a = R_f + \beta_a(R_m - R_f)$$

*Equation 2.1 CAPM model*

The theoretical rate of return for an investment with no risk is known as the risk-free rate. It represents the interest an investor anticipates earnings over a specific period from a risk-free investment (Hayes, 2022). Theoretically, the risk-free rate is the minimum return that investors expect to earn on the investment because they will only accept the additional risk if the potential rate of return is greater than the risk-free rate. Determination of a proxy for the risk-free rate of return for a given situation must consider the investors' home market, while negative interest rates can complicate the issue (Hayes, 2022). In practice, the interest rate on a three-month government Treasury bill (T-bill) is often used as the risk-free rate for investors.

The market risk premium is an additional return to compensate investors for bearing a higher risk from holding risky assets instead of risk-free assets (CFA team, 2022). The market risk premium is part of the CAPM, which analysts and investors use to calculate the acceptable rate of return for an investment. Vineeth (2022) defined market risk premium as the difference between an expected rate of returns on a market portfolio and the rate which is considered risk-free. Investors are needed to offset risks and opportunity costs. The risk-free rate is a theoretical interest paid by an investment at zero risk. According to Chen (2022b), the market risk premium is obtained by the slope of the security market line (SML) (). The required rate of return on equity-linked investments is measured with the CAPM model. It is critical in the modern theory of portfolios. The real equity returns vary with the operational performance of underlying businesses. Hence, the pricing of the markets for such securities reflects it. The past rates of returns have varied as the economy ages and go through cycles, but traditional knowledge has typically calculated the long-term potential of around 8% annually. Investors ask for a premium on the investments in equity instruments as compared to lower-risk alternatives as their investment is more subject to uncertainty, which ultimately paves the way for the equity



premium risk. The market risk premium explains the relationship between treasury bonds and equity market portfolios.

The risk premium shows the required returns, the expected returns, and the historical returns.

Historical market risk is the same for all investors, while the required and expected returns vary across investors, depending on the investing styles and risk tolerance.

A security or portfolio's beta ( $\beta$ ) is essential to measure an investor's risk tolerance (Investopedia, 2021). Risk-averse investors should invest their money in low-beta assets such as Utility and Treasury securities. Investors willing to take on more risk may want to invest in stocks with a higher beta. For individual security, beta is measured by analyzing a stock's past performance to evaluate how its price might move in relation to the overall market. Calculating the beta coefficient of a particular stock can help determine how its returns respond to market fluctuations. For portfolios, beta also allows investors to recognize which investments match their risk tolerance level and which do not. Risk-averse investors tend to put their money into assets with low beta coefficients, such as Treasury bills and utility stocks. Investors who can tolerate a higher degree of risk tend to invest in stocks with higher beta coefficients.

$$\beta_i = \frac{Cov(R_i, R_m)}{Var.(R_m)}$$

Equation 2.2 Beta formula

There are two ways that a stock's beta coefficient can be calculated in practice.

- First, given our conceptual discussion of the CAPM, the above formula can calculate a beta coefficient for securities.
- Secondly, security betas can also be estimated as the slope coefficient in a regression equation between the returns to the securities ( $R_{it}$ ) over time and the returns ( $R_{mt}$ ) to the market portfolio. This regression-based method is often preferred because it is a formal estimation process.

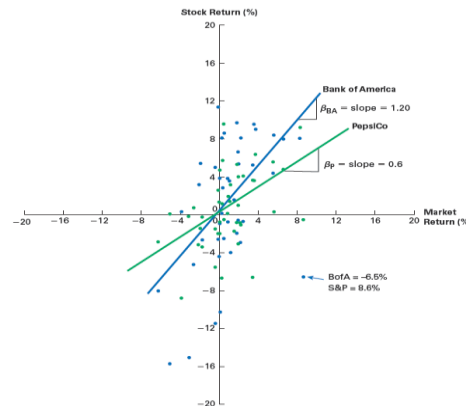

Figure 2.1 The relationship between Betas for Bank of America and Pepsi

Estimating Betas for Bank of America and Pepsi: The blue line is Bank of America's characteristic line. Each blue dot represents the return on Bank of America and the S&P 500 in a specific month.

This line's slope, which is Bank of America's beta (1.2), shows how well that stock responds to changes in market returns. The green dots are monthly returns on Pepsi and the S&P 500; the green line is Pepsi's characteristic. Pepsi's beta is 0.6 (Smart & Zutter, 2020).

CAPM is the first asset pricing model that helps investors and financial managers evaluate stocks and select efficient portfolios (Pham, 2017). This asset pricing model was ideally studied by American economists such as John Lintner, Jack Treanor, and Jesse Morson; later on, in the 1970s and 1980s, there were some empirical tests by scholars, and there were questions on the validity of the beta (Xiao et al., 2019). Benninga (2008) mentioned that the experiment by plotting the security market line did not work out well. There is not much evidence in favor of the SML; neither the R<sup>2</sup> of the regression nor the t-statistics give much evidence that there is a relation between expected return and the portfolio. According to Xiao et al. (2019), the CAPM describes the formation of market equilibrium when investors adopt Markowitz's theory for investment management and considers that there is a positive correlation between the expected return rate of an asset and the  $\beta$ -coefficient, which is a yardstick to measure the risk of the asset. Benninga (2014) has considered that there are several reasons why these disappointing results of CAPM, and there may be some reasons as follows:

- One reason is that the CAPM itself does not hold. There are several possible explanations for this:
  - + Short sales of assets may be restricted in the market. Our derivation of the CAPM assumes that there are no short-sale restrictions. This is an unrealistic assumption. In this case, however, there is no simple relationship between the returns of assets and their beta. The SML is especially unlikely to continue if short sales are restricted.
  - + Individuals may not have homogeneous probability estimates or have exact expectations about value returns, variances, and covariances.
- Perhaps the CAPM holds only for portfolios and not for single assets.
- Perhaps our set of assets is not large enough: After all, the CAPM talks about all risky assets, whereas we have chosen to test a minimal subset of these assets for illustrative purposes. In the CAPM testing, tests involving bonds, real estate, and even non-diversifiable assets like human capital have been added to the list of risky assets.
- Perhaps the "market portfolio" is not efficient. The mathematics of efficient portfolios suggests this possibility.

- Perhaps the CAPM holds only in the event of positive market returns (they were, on average, negative over the surveyed period).

Some critical literature reviews revealed some advantages and disadvantages of CAPM. This study used CAPM to evaluate asset pricing in CSX.

### 3. Methodology

This study tests CAPM's efficiency in the Cambodia Securities Exchange. The official website of CSX, " <http://csx.com.kh>," is the primary source for data collection of daily stock prices in the study. There are nine equities listed companies on CSX until the present, including three state-owned companies and six other private companies. They have different market capitalizations and are also traded daily in different amounts. The study chose two state-owned companies, Phnom Penh Autonomous Port (PPAP) and Sihanoukville Autonomous Port (PAS), to test their efficiency on the market index by using CAPM.

Daily data prices were collected, and both companies' monthly and yearly rates of return were computed. The collected data recorded daily prices since the companies were listed on CSX (PPAP was listed on 22 September 2015, and PAS was listed on 8 June 2017). The CSX market index was also collected for the same periods as PPAP and PAS data to compute their correlation coefficients and betas. According to Benninga (2014), the stock return was computed as follows:

$$r_t = \ln\left(\frac{P_{t+1}}{P_t}\right) \text{ (When data were continued or time series data) or}$$

$$r_t = \ln\left(\frac{P_{t+1}}{P_t}\right) - 1, \text{ (When data were discrete)}$$

*Equation 3.1 Stock return formula*

Where:

$r_t$  – Return of investment in time t

$P_{t+1}$  – Asset price in time t+1

$P_t$  – Asset price in time t, and

$\ln$  – natural logarithm

This study collected all time series data since the stock market was traded daily, so  $r_t = \ln\left(\frac{P_{t+1}}{P_t}\right)$  was applied to compute the daily return for the study. The monthly return for each asset and market index was computed as an average daily return multiplied by the number of trading days (Benninga, 2014). The daily traded price of PPAP was collected from September 2015 to September 2022 and PAS from June 2017 to September 2022, and the market index was collected accordingly. According to Benninga (2014), the return data for the 60 months represents the distribution of the returns for the coming month; thus, this study assumed that historical data could help us predict how returns would behave in the future. This assumption

allows us to assume that the average of the historical data represents the expected monthly return on each stock. Each asset's coefficient of correlation and beta were computed as follows (Lind, Marchal, & Wathen, 2021; Doane & Seward, 2016):

$$r = \frac{\sum_{i=1}^n (x - \bar{x})(y - \bar{y})}{\sqrt{\sum_{i=1}^n (x - \bar{x})^2} \sqrt{\sum_{i=1}^n (y - \bar{y})^2}}$$

**Equation 3.2 Correlation Coefficient formula**

$$b_i = \frac{\sum (x - \bar{x})(y - \bar{y})}{\sum (x - \bar{x})^2}$$

**Equation 3.3 Beta formula**

$$b_0 = \bar{y} - b_i \bar{x}$$

**Equation 3.4 Alpha formula**

To test the efficiency of the CAPM model, the study also compared the model results with forecasting results by using a single moving average and weighted moving average. To forecast the expected return of each asset, we use the CAPM model as per the below formula:

$$R_a = R_f + \beta_a (R_m - R_f) \text{ (Smart \& Zutter, 2020)}$$

Where:

- $R_a$  is the expected return on the asset
- $R_f$  is a risk-free rate
- $R_m$  is the market index return
- $\beta_a$  is the coefficient or index of non-diversifiable risk for investment

According to Render et al. (2018), the forecast values are compared with the actual or observed values to see how well one model works or to compare that model with others. The forecast error (or deviation) is defined as follows:

$$\text{Forecast error} = \text{Actual value} - \text{Forecast value}$$

**Equation 3.5 Forecast Error formula**

The mean absolute deviation (MAD) is needed to compute to measure the model's accuracy. This is computed by taking the sum of the absolute values of the individual forecast errors and dividing by the number of errors (n):

$$\text{MAD} = \frac{\sum [\text{Forecast Error}]}{n}$$

**Equation 3.6 Mean Absolute Deviation formula**

The small MAD is a better model than the large MAD.

#### 4. Results

##### *Compute daily return*

The market prices of the two assets were collected from the official website of CSX, "http://csx.com.kh," and then the daily return was computed using  $r_t = \ln\left(\frac{P_{t+1}}{P_t}\right)$ , respectively, since the data are time-series. In this case, to compute the return on 29 September 2022 of PAS, the following formula was used:

$$r_t = \ln\left(\frac{P_{t+1}}{P_t}\right) = \ln(13,000/13,000) = 0$$

To compute return on 28 September 2022, we used:

$$r_t = \ln\left(\frac{P_{t+1}}{P_t}\right) = \ln(13,000/12,960) = 0.00308 \text{ or } 0.308\%$$

Table 4.1 The daily return of PAS stock price

Date	Price	Daily Return
30/09/2022	13,000	
29/09/2022	13,000	0.000%
28/09/2022	12,960	0.308%
27/09/2022	13,000	-0.308%
23/09/2022	13,020	-0.154%
22/09/2022	12,980	0.308%
21/09/2022	12,820	1.240%
20/09/2022	12,800	0.156%
19/09/2022	13,200	-3.077%
16/09/2022	13,160	0.303%
15/09/2022	13,180	-0.152%
14/09/2022	13,240	-0.454%
13/09/2022	13,220	0.151%

We followed the same procedure for PAS from 1 August 2017 until 29 September 2022.

To compute the daily return of PPAP from 9 December 2015 to 29 September 2022, the computation is as follows:

To compute return on 29 September 2022 of PPAP:

$$r_t = \ln\left(\frac{P_{t+1}}{P_t}\right) = \ln(14,400/14,380) = 0.00139 \text{ or } 0.139\%$$

To compute return on 28 September 2022:

$$r_t = \ln\left(\frac{P_{t+1}}{P_t}\right) = \ln(14,380/14,380) = 0 \text{ or } 0\%$$

Table 4.2 The daily return of PPAP stock price

Date	Price	Daily Return
30/09/2022	14,400	
29/09/2022	14,380	0.139%
28/09/2022	14,380	0.000%
27/09/2022	14,460	-0.555%
23/09/2022	14,440	0.138%
22/09/2022	14,420	0.139%
21/09/2022	14,400	0.139%
20/09/2022	14,400	0.000%
19/09/2022	14,400	0.000%
16/09/2022	14,420	-0.139%
15/09/2022	14,280	0.976%
14/09/2022	14,500	-1.529%
13/09/2022	14,600	-0.687%

We used the same procedure for PPAP and PAS in accordance with the market index to calculate daily returns.

#### Compute Asset Beta

To compute the beta of each asset, at least 60 monthly returns on each asset and the market index are needed. The monthly return for each asset and market index was computed as an average daily return multiplied by the number of trading days (Benninga, 2014). Using the monthly return of asset data on the Y-axis and market index monthly data on the X-axis, the beta of assets was computed using the statistical formula as follows:

The average monthly return of PPAP during the study period is:

$$\bar{y} = \frac{6.77\% - 0.73\% + \dots - 2.61\%}{82} = 1.25\%$$

The average monthly return of the market index during the study period is:

$$\bar{x} = \frac{3.39\% - 3.95\% + \dots - 0.23\%}{82} = 0.18\%$$

The beta of PPAP during the period of study is:

$$\beta = \frac{\sum(x - \bar{x})(y - \bar{y})}{\sum(x - \bar{x})^2}$$

$$\beta_{PPAP} = \frac{(3.39\% - 0.18\%)(6.77\% - 1.25\%) + \dots + (-0.23\% - 0.18\%)(-2.61\% - 1.25\%)}{(3.39\% - 0.18\%)^2 + \dots + (-0.23\% - 0.18\%)^2} = 0.47$$

Table 4.3 Comparing between PPAP and Index monthly return

Item	Date	PPAP monthly return	INDEX monthly return
1	01/12/2015	6.770%	3.388%
2	01/01/2016	-0.730%	-3.947%
3	01/02/2016	0.000%	0.630%
4	01/03/2016	-0.367%	-1.014%
5	01/04/2016	-0.738%	-2.507%
70	01/09/2021	-0.535%	-1.142%
71	01/10/2021	-0.673%	-1.837%
72	01/11/2021	-1.361%	-1.684%
73	01/12/2021	2.034%	-2.782%
74	01/01/2022	0.000%	-0.017%
75	01/02/2022	0.000%	19.582%
76	01/03/2022	4.591%	-1.442%
77	01/04/2022	-0.514%	-5.849%
78	01/05/2022	-0.776%	-4.153%
79	01/06/2022	-0.651%	-3.297%
80	01/07/2022	-2.649%	-3.106%
81	01/08/2022	-0.809%	-1.444%
82	01/09/2022	-2.605%	-0.231%

The average monthly return of PAS during the study period is:

$$\bar{y} = \frac{0.398\% + 0\% + \dots - 1.98\%}{62} = 1.54\%$$

The average monthly return of the market index during the study period is:

$$\bar{x} = \frac{0.24\% + 0.56\% + \dots - 0.23\%}{62} = 0.55\%$$

Beta of PAS during the period of study is:

$$\beta = \frac{\sum(x - \bar{x})(y - \bar{y})}{\sum(x - \bar{x})^2}$$

$$\beta_{PAS} = \frac{(0.24\% - 0.55\%)(0.40\% - 1.54\%) + \dots + (-0.23\% - 0.55\%)(1.98\% - 1.55\%)}{(0.24\% - 0.55\%)^2 + \dots + (-0.24\% - 0.55\%)^2} = 0.94$$

Table 4.4 Comparing between PAS and Index monthly return

Item	Date	PAS monthly return	INDEX monthly return
1	Aug-17	0.398%	0.237%
2	Sep-17	0.000%	0.560%
3	Oct-17	-2.410%	2.352%
4	Nov-17	0.406%	-3.578%
5	Dec-17	0.806%	2.802%
50	Sep-21	-0.147%	-1.142%
51	Oct-21	-1.783%	-1.837%
52	Nov-21	0.449%	-1.684%
53	Dec-21	-0.299%	-2.782%
54	Jan-22	-0.150%	-0.017%
55	Feb-22	3.100%	19.582%
56	Mar-22	1.729%	-1.442%
57	Apr-22	-0.861%	-5.849%
58	May-22	3.539%	-4.153%
59	Jun-22	-4.117%	-3.297%
60	Jul-22	-0.873%	-3.106%
61	Aug-22	-3.118%	-1.444%
62	Sep-22	-1.980%	-0.231%

To use CAPM, a risk-free rate is needed. According to Xinhuanet (2022), an article dated 7 September 2022 mentioned that the Cambodian government bond has a fixed interest rate of 2 percent per annum. Since it is an auctioned rate, so in this study, we used a risk-free rate of 2%.

Using computed betas and the risk-free rate above, we can forecast the expected return of PPAP and PAS as follows (Smart & Zutter, 2020):

$$R_a = R_f + \beta_a (R_m - R_f)$$

Where:

- $R_a$  is the expected return on the asset
- $R_f$  is a risk-free rate
- $R_m$  is the market index return
- $\beta_a$  is the coefficient or index of non-diversifiable risk for investment

We computed the expected return of PPAP by using CAPM:



Table 4.5 Expected return of PPAP by using CAPM

Year	Actual return	Market return	Beta of PPAP	Expected return by CAPM	Estimation Error	Absolute Deviation
2016	-5.61%	-11.63%	0.465	-4.34%	-1.27%	1.27%
2017	-1.98%	-8.68%	0.465	-2.97%	0.99%	0.99%
2018	39.63%	36.35%	0.465	17.97%	21.66%	21.66%
2019	49.23%	44.25%	0.465	21.65%	27.59%	27.59%
2020	-6.61%	-17.31%	0.465	-6.98%	0.36%	0.36%
2021	24.18%	-31.66%	0.465	-13.65%	37.83%	37.83%
2022	-3.41%	0.04%	0.465	0.82%	-4.24%	4.24%

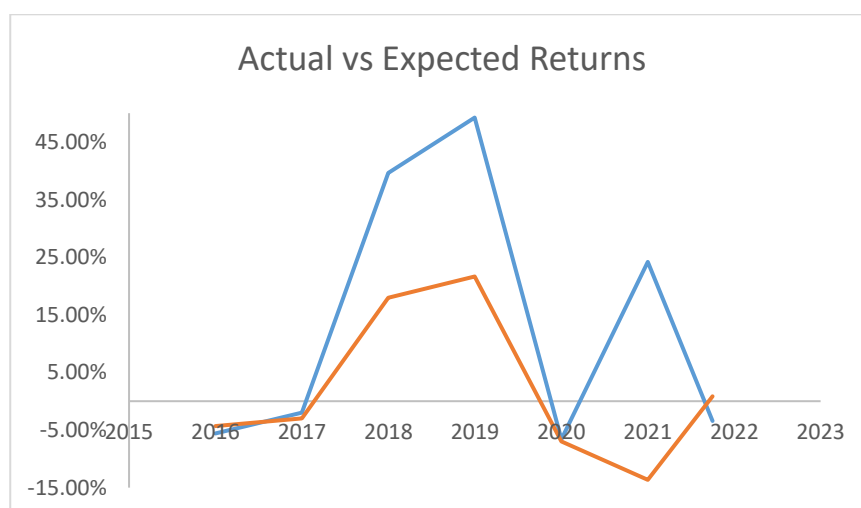

Figure 4.2 Comparing between Expected and Actual return of PPAP

We also computed the expected return of PAS by using CAPM:

Table 4.6 Expected return of PAS by using CAPM:

Year	Actual return	Market return	Beta of PPAP	Expected return by CAPM	Estimation Error	Absolute Deviation
Aug. 2017 to Jul. 2018	2.36%	-2.59%	0.943	-2.33%	4.69%	4.69%
Aug. 2018 to Jul. 2019	100.91%	66.47%	0.943	62.79%	38.12%	38.12%
Aug. 2019 to Jul. 2020	5.92%	6.32%	0.943	6.07%	-0.15%	0.15%
Aug. 2020 to Jul. 2021	-9.53%	-22.03%	0.943	-20.66%	11.12%	11.12%

Aug. 2021 to Jul. 2022      0.59%      -12.44%      0.943      -11.62%      12.21%      12.21%

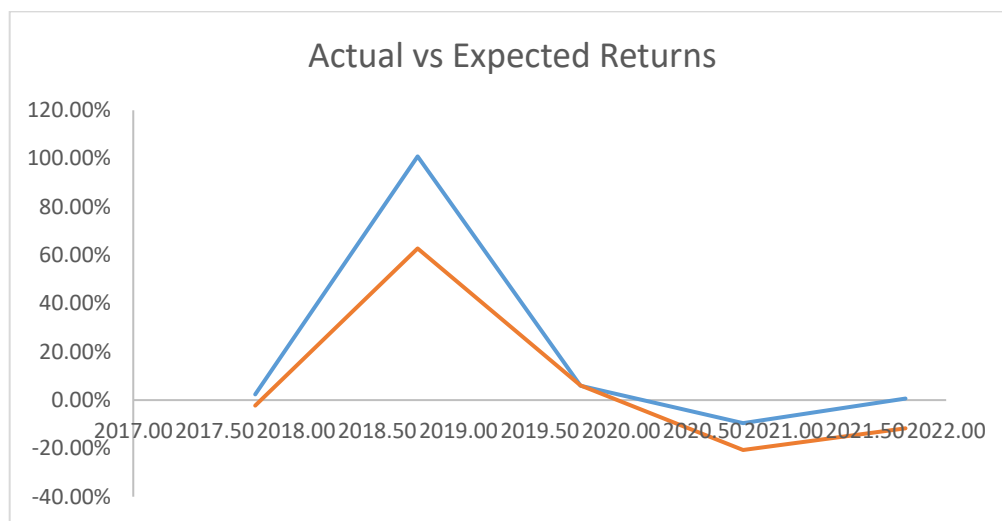

Figure 4.2 Comparing between Expected and Actual return of PAS

The graphics above showed the errors of expected returns compared to actual returns. The errors can be computed as average (Render et al., 2018).

$$\text{MAD of PPAP} = \frac{1.27\% + 0.99\% + \dots + 4.24\%}{7} = 13.42\%$$

$$\text{MAD of PAS} = \frac{4.69\% + 38.12\% + \dots + 12.21\%}{5} = 13.26\%$$

The graphics show that there are almost undervaluation by using CAPM to forecast stock returns (PPAP & PAS). Despite different beta values, the mean absolute deviations were almost the same (around 13%).

To compute the forecast error, there is a need to compare the actual and forecast returns (Render et al., 2018); Forecast error = Actual value - Forecast value. Forecast errors of PPAP and PAS were shown in the tables 4.5 and 4.6 mean forecast errors are computed as follows:

$$\text{Forecast error of PPAP} = \frac{-1.27\% + 0.99\% + \dots - 4.24\%}{7} = 11.85\%$$

$$\text{Forecast error of PAS} = \frac{4.69\% + 38.12\% + \dots + 12.21\%}{5} = 13.20\%$$

Both stocks were undervaluation by using the CAPM model to estimate return. PPAP was 11.85% undervalued, and PAS was 13.20% undervalued.

## 5. Conclusion

According to the above results, there are better tools than the CAPM model to estimate the PPAP and PAS in CSX. As a result of the analysis, it is revealed that the return from investment was undervalued. For further research, the CAPM was inappropriate for forecasting PPAP and PAS

stock prices. We recommend using other methods rather than CAPM because these two stock prices were unrelated to the CSX index.

## References

- Beattie, A. (2022). *The birth of stock exchanges*. Retrieved from <https://www.investopedia.com/articles/07/stock-exchange-history.asp>
- Benninga, S. (2008). *Financial modeling: using Excel* (3<sup>rd</sup> ed.). Cambridge, England, The MIT Press.
- Benninga, S. (2014). *Financial modeling: using Excel* (4<sup>th</sup> ed.). Cambridge, England, The MIT Press.
- Berk, J. & DeMarzo, P. (2020). *Corporate Finance* (5<sup>th</sup> Global Edition). Essex, UK. Pearson Education Limited.
- Bodie, Z., Kane, A., & Marcus, J. A. (2021). *Investments* (12<sup>th</sup> ed.). New York, NY. McGraw-Hill Education.
- CFI Team (2022). *Market Risk Premium: A level of return a market generates that exceeds the risk-free rate*. Retrieved from <https://corporatefinanceinstitute.com/resources/knowledge/finance/market-risk-premium/>
- Chen, J. (2022a). *Investment view*. Retrieved from <https://www.investopedia.com/terms/i/investment-view.asp>
- Chen, J. (2022b). *What Is Market Risk Premium? Explanation and Use in Investing*. Retrieved from [https://www.investopedia.com/terms/m/marketriskpremium.asp#:~:text=The%20market%20risk%20premium%20\(MRP,asset%20pricing%20model%20\(CAPM\)\)](https://www.investopedia.com/terms/m/marketriskpremium.asp#:~:text=The%20market%20risk%20premium%20(MRP,asset%20pricing%20model%20(CAPM)))
- Coffie, W. (2012). *Capital asset pricing model and the three factors model: empirical evidence from emerging African Stock markets* (Unpublished Doctoral thesis). Birmingham City University, UK.
- CSX (2022). *List of companies*. Retrieved from <http://csx.com.kh/data/lstcom/listPosts.do?MNCD=50101>.
- Doane, P. D. & Seward, E. L. (2016). *Applied statistics in Business and Economics* (5th ed.). New York, NY: McGraw-Hill.
- Fabinu I. B., Makinde K., & Folorunso A. O. (2017). Empirical analysis of capital assets pricing model (CAPM) as a tool for valuation of a company's returns. *Net Journal of Business Management*, 5(2), 30-40.
- Hayes, A. (2022). *What is the risk-free rate of return, and does it really exist?* Retrieved from <https://www.investopedia.com/terms/r/risk-freerate.asp>
- Hwang, I. (2021). *A brief history of the stock market*. Retrieved from <https://www.sofi.com/learn/content/history-of-the-stockmarket/#:~:text=The%20first%20modern%20stock%20trad>

- ing%20was%20created%20in%20Amsterdam%20when,Amsterdam%20stock%20excha  
nge%20was%20created.
- Investopedia team (2021). *Using Beta to Understand a Stock's Risk*. Retrieved from <https://www.investopedia.com/investing/beta-gauging-price-fluctuations/#:~:text=Beta%20is%20a%20measurement%20of,down%20compared%20to%20other%20stocks>.
- Kenton, W. (2022). *Beta: Definition, Calculation, and Explanation for Investors*. Retrieved from <https://www.investopedia.com/terms/b/beta.asp>
- Lind, A. D., Marchal, W. G. & Wathen, S. A. (2021). *Statistical technique in Business and Economics* (18th Ed.). New York, NY: McGraw-Hill Education.
- Lintner, J. (1965). Security Prices, Risk and Maximal Gains from Diversification. *The Journal of Finance*, 20 (4), pp. 587-615.
- Mossin, J. (1966). Equilibrium in a Capital Asset Market. *Econometrica*, 34(4), 768–783.
- Nel, W. S. (2011). The application of the Capital Asset Pricing Model (CAPM): A South African perspective. *African Journal of Business Management*, 5(13), 5336–5347.
- Perold, F. A. (2004). The capital asset pricing model. *Journal of Economic Perspectives*, 18 (3), 3-24.
- Pham, T. H. (2017). *Testing the capital asset pricing model (CAPM) in the Vietnamese stock market: An analysis of two sub-periods from 2006 to 2016*. (Unpublished Bachelor Thesis). Espoo, Finland. Aalto University.
- Reilly, K. F., Brown, C. K., Hedges, L. P., & Chang, C. P. (2010). *Investment analysis and portfolio management*. Toronto, Ontario, Canada. Nelson Education Ltd.
- Reilly, K. F., Brown, C. K., & Leeds, J. S. (2019). *Investment analysis and portfolio management* (11<sup>th</sup> ed.). Boston, MA. Cengage Learning.
- Render, B., Stair, R. M. jr., Hanna, M. E. & Hale, T. S. (2018). *Quantitative analysis for management* (13<sup>th</sup> Global ed.). Essex, UK. Pearson Education Limited.
- Ross, S. A.; Westerfield, R. W.; Jaffe, J. & Jordan, B. D. (2016). *Corporate Finance* (11<sup>th</sup> Ed.). New York: McGraw-Hill Education.
- Rossi, M. (2016). The capital asset pricing model: a critical literature review. *Global Business and Economics Review*, 18(5), 604–617.
- Rossvoll, E. (2013). *Asset pricing models and the Norwegian Stock Market* (Unpublished Doctoral Thesis). Norwegian University of Science and Technology, Norway.
- Sharpe, F. W. (1964). Capital Asset Prices: A Theory of Market Equilibrium under Conditions of Risk. *Journal of Finance*, 19 (3), 425–442.
- Smart, B. S., & Zutter, J. C. (2020). *Fundamentals of investing* (14<sup>th</sup> ed.). London, UK. Pearson Education Limited.
- Vineeth (2022). *Market Risk Premium*. Retrieved from <https://cleartax.in/g/terms/market-risk-premium>

- Wang, Y. (2016). *Empirical essays on asset pricing in the Chinese Stock Market* (Unpublished Doctoral Thesis). University of York, UK.
- Wikipedia (2022). *Cambodia security exchange*. Retrieved from [https://en.wikipedia.org/wiki/Cambodia\\_Securities\\_Exchange](https://en.wikipedia.org/wiki/Cambodia_Securities_Exchange).
- Xiao, Z., Yang, Y., Li, L., & Zhong, Y. (2019). Empirical test of the effectiveness of CAPM for Shanghai Stock Market-Based on Industry Grouping. *Advances in Economics, Business and Management Research*, p. 106. Atlantis Press.
- XINHUANET (07- Sep. 2022). *Cambodia issues 1st gov't bond of 24.3 mln USD*. Retrieved from <https://english.news.cn/20220907/f3866cbf96204fe9921714fdcd666a2/c.html#:~:text=The%20bond%20offers%20a%20fixed,the%20bond%20is%20one%20year>.
- Zhao, Z. (2014). *The Empirical Study of Size Effect, Book-to-Market Effect in US Security Market* (Unpublished Master Thesis). Logan, Utah. Utah State University.
- Zhou, T., & Liu, H. (2018). *Empirical study on CAPM model on China stock market* (Unpublished Master Thesis). Smaland, Swidden. JÖNKÖPING University.

## Customers' Satisfaction with ATM Service Quality of ACLEDA Bank

Satya Somatin Chhnoeum, Raingsey Keo, Muoyseam Chang, Soren Chea, and Sinit To

Corresponding Author. Email: keoraingsey.168@gmail.com  
ACLEDA INSTITUTE OF BUSINESS, Phnom Penh, Cambodia

### ABSTRACT

*This study aims to identify the factor that influences customer satisfaction with the ATM service quality of ACLEDA Bank Plc. by adopting the SERVQUAL Model such as Performance Tangibility, Reliability, Responsiveness, Assurance, and Empathy. To achieve this objective, a quantitative method was employed with a sample size of 204 ATM end users of ACLEDA Bank Plc. Descriptive statistics were used to indicate the satisfaction level of respondents. Cronbach's alpha was used to check the variables for reliability and correlations and multiple regression were used to test the hypothesis. The study shows that Tangibility, Reliability, Responsiveness, Assurance, and Empathy were statistically significant and positively correlated with customer satisfaction. This research is a useful contribution to the banking industry especially in Cambodia. Further research should be conducted in other areas of the banking industry to seek further insights into this service industry in Cambodia.*

**Keywords:** Automated Teller Machine (ATM), Customer Satisfaction, Service Quality

## 1. Introduction

### *Background of study*

Technological advances in the industrial revolution 4.0 era have led to the innovation of products and services in both public and private institutions, including financial institutions. The services have been transformed from using human resources to using machines and technology. Noticeably, a commercial bank has introduced Automated Teller Machines (ATMs) to serve customers to make financial transactions – withdrawals and deposits – without the need for a bank teller (cashier). ATMs have helped banks meet their customers' needs through high-quality services (Alexis & Chen, 2019).

The first ATM appeared at a branch of Barclay's Bank in London in 1967 although there were reports of cash dispensers in Japan in the mid-1960s (Kagan, 2023). In Cambodia, ATMs were reportedly first introduced in Cambodia by Canadia Bank in 2004 (Makara, 2011). The number of new bank ATM terminals in Cambodia increased slightly by 22 percent, according to the National Bank of Cambodia (NBC) (2018).

NBC licensed ACLEDA Bank Limited as a Specialized Bank on October 07, 2000 (ACLEDA Bank, 2020). ACLEDA Bank Plc. was then licensed by NBC on December 01, 2003 as a Commercial Bank so that it can provide complete banking services according to the needs of the customers and the market. Initially, there were only 20 ATMs installed at ACLEDA Bank. ACLEDA Bank Plc. has noticeably expanded its ATM network within a few years. Nowadays ACLEDA Bank has the largest ATM network, with 655 ATMs (September 04, 2020) throughout Cambodia.

### *Problem statement*

Financial institutions in Cambodia are facing competition in attracting customers to their services. There are 54 commercial banks excluding their branches operating in Cambodia, according to the NBC report on 31 December 2021. They have digitalized their products to meet the needs of customers and compete with other banks in the financial sector, while Cambodians have wished to spend less time on banking services, by using digital banking services such as ATM withdrawals and deposits and mobile banking transactions.

ATMs play an important role in serving customers for withdrawals, deposits, and other transactions while the bank is focusing on the quality of services and functions of ATMs. ACLEDA Bank is one of the potential commercial banks in Cambodia that provides ATM services with 655 ATMs (September 04, 2020) throughout Cambodia. Managers in charge of marketing both goods and services are increasingly implementing service quality and customer satisfaction to measure business performance (Anderson et al., 1994; Rust & Zahorik, 1993).

To know customer satisfaction with ATM service, a study on the relationship between service quality and customer satisfaction with ATM service is very important to increase the efficiency of bank ATM service in the future (Adepoju, E. & Alhassan, B. 2010). Although research on the impact of service quality on customer satisfaction has been conducted in different contexts, in Cambodia, especially with regard to bank ATM services, it is still rare. Even a few researchers have implemented the SERVQUAL model to measure service quality in financial institutions in Cambodia.

### *Research objective*

The main objective of this study is to identify the factor that influences customer's satisfaction with the ATM service quality of ACLEDA Bank Plc. by adopting the SERVQUAL Model, such as Performance Tangibility, Reliability, Responsiveness, Assurance, and Empathy.

### *Research question*

What factors influence customers' satisfaction with the ATM service quality of ACLEDA Bank Plc in Cambodia?

### *Significance of the study*

The research will benefit Cambodia's banking industry by enhancing ATM service quality. In addition, the results of this study will help support bank management and bank branch managers to improve customer satisfaction more effectively and efficiently. Furthermore, this study will contribute to future research and academics on ATM service quality, particularly within the Cambodian context.

## **2. Literature Review**

### *ATM Service*

ATM is a computerized telecommunications device that gives customers access to financial transactions in public without needing a human clerk or bank teller (Magara, 2018). In modern ATMs, the consumer is identified by inserting a plastic card with a security chip containing a unique card number and some security information, like an expiration date.

### *Customer satisfaction*

Customer satisfaction is the degree to which a customer perceives that an individual, firm or organization has effectively provided a product or service that meets the customer's needs in the context in which the customer is aware of and/or using the product or service (Cengiz, 2010). Hence, the more satisfied customers are, the better business the company runs (Juneja, 2015).



Customers satisfaction is described as a measure of how products or services supplied by an organization meet customers' expectations, and this is one of the keys to ensuring business success because customers' satisfaction will determine the market growth of the organization in the future (Ibrahim et al., 2016).

### *Service quality*

Philip Kotler and Gary Armstrong defined the term “service quality [SQ]” as the ability of a service firm to hang on to its customer. That is, in their opinion customer retention is the best measure of SQ (Ramya et al., 2019). According to Lewis and Booms (1983) defined SQ as a measure of how well a service delivered matches the customers' expectations, a definition used by other researchers, including Lewis & Mitchell (1990). Robinson (1999) identified SQ as an attitude or global judgment about the superiority of a service, whereas Grönroos (1990) described SQ as an outcome of a comparison that customers make between their expectations about service and their perceptions of how the service has been performed. Gronroos's (1990) definition of SQ had similarities with Westbrook's definition of customer satisfaction (1980) in that both are responses or outcomes of comparison between expectations and perceived performance.(Considerations, 2018)

### *Toward conceptual framework and hypothesis*

Model (SERVQUAL) was used to analyze Customers’ Satisfaction toward ATM Service Quality of ACLEDA Bank; SERVQUAL Models are Tangibility, Reliability, Responsiveness, Assurance, and Empathy (A Parasuraman et al., 1988; Lim & Tang, n.d.; Ahmed et al., 2017).

**Tangibility:** Parasuraman et al. (1985) and Kotler (2012) identified tangible materials as physical facilities, equipment, personnel, and communication tool (Value 11).

**Reliability:** the ability to perform the services promised with Reliability and accuracy (Parasuraman et al. 1985; Kotler, 2012).

**Responsiveness** refers to the willingness to help customers and provide services quickly (Parasuraman et al. 1985; Kotler, 2012).

**Assurance** refers to employees' knowledge, courtesy, and ability to generate trust and confidence (Parasuraman et al. 1985; Kotler, 2012).

**Empathy** refers to a willingness to care and provide personal attention to customers (Parasuraman et al., 1985). Kotler (2012) described Empathy as the willingness to provide deep concern and specific service to each customer.

Previous study found that tangibility, reliability, responsiveness, and assurance influence customer satisfaction of a banking hall of ACLEDA Bank Plc. (Taing et al., 2021). Moreover, another study found empathy influence customer satisfaction in a telecommunication service (Loke et al., 2011).

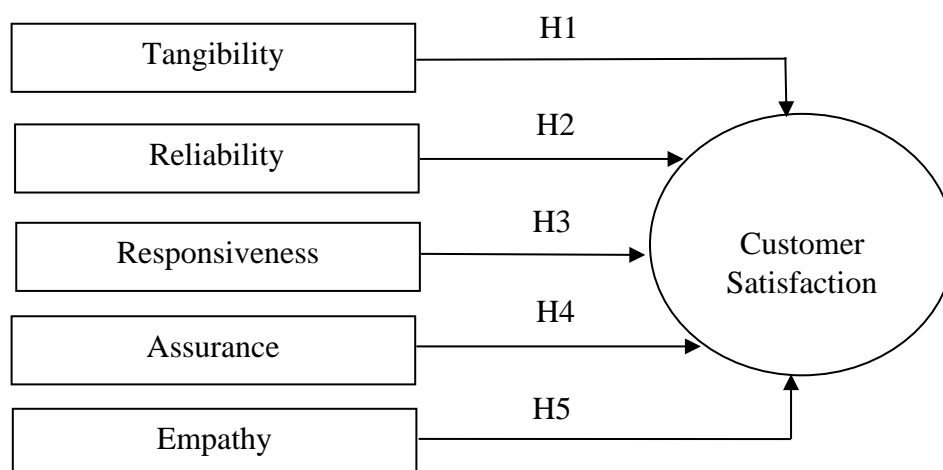

Figure 1: Conceptual Model

### *Hypotheses for research study*

According to the conceptual Model, the following hypotheses have been proposed.

- H1: Tangibility has a significant relationship with customer satisfaction.
- H2: Reliability has a significant relationship with customer satisfaction.
- H3: Responsiveness has a significant relationship with customer satisfaction.
- H4: Assurance has a significant relationship with customer satisfaction.
- H5: Empathy has a significant relationship with customer satisfaction.

## **3. Methods**

### *Research design*

This research study employed quantitative methods (Schindler, 2019) to identify the factors that influence customer's satisfaction with ATM service quality of ACLEDA Bank Plc. by adopting SERVQUAL models such as performance Tangibility, Reliability, Responsiveness, Assurance, and Empathy.

### *Population and sample*

The target population in this study was Cambodian people who were living in Phnom Penh City, Cambodia; the targeted samples were consumers who have been using ATM service (ATM user) of ACLEDA Bank Plc. As it was impossible for the researcher, within the time constraints, data were collected using a convenience sampling technique. The study selected 204 ATM users as

the sample size, representing 1,602,969 existing clients of ACLEDA Bank Plc (September 22, 2020). For the sample size, the number was calculated by using the formula of (Yamane, 1967).

### Research respondents

The total number of the respondents is 204; the respondents were aged between 18–45 years, education level is a bachelor or master and other. Occupations include businessman/woman; company employee; government officer; teacher, worker; student, and others. Table 2 indicates that 64.2 percent of the respondents are female, whereas 35.8 of them are male. Regarding age, there were 37.3% aged between 18 - 25 years, 39.7% aged between 26 - 35 years, and 23% aged between 36 - 45 years. Education level, there were 84.3 percent have a bachelor's degree, 15.2 percent have a master's degree, and 0.5 percent have other education levels. Occupation, the result shows that 69.1% of respondents are company employees and 15.2% of 204 people are students. Furthermore, the most accessed service of ATMs is Cash /Cardless cash withdrawal is more than three quarters and followed by Deposit.

Table 1: Demographic Profile of Respondents

Item	Category (N= 204)	Frequency	Percentage
Gender	Female	131	64.2%
	Male	73	35.8%
Age	18 - 25 years	76	37.3%
	26 - 35 years	81	39.7%
	36 - 45 years	47	23%
	Bachelor	172	84.3%
Education	Master	31	15.2%
	Other	1	0.5%
	Businessman/woman	20	9.8%
Occupation	Company Employee	141	69.1%
	Government officer	5	2.5%
	Teacher	5	2.5%
	Worker	1	0.5%
	Student	31	15.2%
	Other	1	0.5%
ATM services	Cash / Card less cash withdrawal	195	95.5%
	Deposit	5	2.5%
	Mobile top up	3	1.5%
	Balance inquiry	1	0.5%
	Everyday	26	12.7%
How often do you use an ATM	Once a week	48	23.5%
	Three-four times a week	46	22.5%
	Once a month	17	8.3%
	When necessary	67	32.8%

*Research tools & measurements of constructs*

The survey questionnaire was used to collect the primary data, which was a series of pre-determined questions (Cooper & Schindler, 2011). The measure questions were designed by adopting the statements of (Mwatsika, 2016) and Magara (2018). This questionnaire was for the targeted samples: consumers using the ATM service of ACLEDA Bank Plc. The total of 385 questionnaires were distributed to the ATM users. The questionnaire was distributed into three main sections, the first was related to the demographic detail of respondents; the second is the function of ATM that respondents have been using; and the third is service quality of ATMs. SERVQUAL Model developed by Parasuraman (1988) was used. There were 23 items constructed from five dimensions of the SERVQUAL Model: Tangibility (6 items), Reliability (5 items), Responsiveness (4 items), Assurance (3 items), and Empathy (5 items), as shown below:

Table 2: Number of Items in Each Dimension

No.	Dimensions	Number of items
1	Tangibility	6
2	Reliability	5
3	Responsiveness	4
4	Assurance	3
5	Empathy	5

The remaining one variable (1 item) was used to measure customer satisfaction level on the service quality of ATM were asked based on a 5-point Likert scale. The five points as shown below:

Table 3: Five-points Likert Scale

Dimensions	Number of items
Strongly Agree	5
Agree	4
Neutral	3
Disagree,	2
Strongly Disagree,	1

*Data collection*

In addition to the primary data, the secondary data was obtained from relevant literature collected from diverse sources of information such as journals, reports, and accessible information on the Internet. Due to the COVID-19 outbreak and based on Yamane (1967), the primary data using the questionnaires were collected using Google Forms; the link was sent to targeted respondents via telegram, Facebook messenger, and other online channels.

### Data analysis

Descriptive statistics using Statistical Package for the Social Sciences (SPSS 25) was conducted to analyze the data obtained from the participants. The descriptive statistics involve mean and standard deviation, tables, and graphs. Cronbach's alpha was used to check the variables for Reliability. Correlations and multiple regression were used to test the hypotheses.

### Ethical consideration

Since the targeted respondents were ATM users of ACLEDA Bank Plc., three ethical questions must be addressed. First, the letter of consent was used as an official permission from the Bank for data collection. Second, the researcher must keep anonymous all the information of respondents. Third, the researcher also gives credit to previous researchers and authors for citation to avoid plagiarism.

## 4. Results

### Analysis of level of agreement

The following data analysis result indicates respondents' satisfaction with the ATM service quality of ACLEDA Bank. Table 4 illustrates the minimum, maximum, mean, and SD and will then analyze the agreement level. The means of opinion from respondents for each factor indicates the effecting level of those factors. Since the research used a 5- point rating scale, the means from 3.40 to 4.19 were considered a level of agreement.

Table 4: Level of agreement

Variables	Minimum	Maximum	Mean	SD	Level of Agreement
Tangibility	2.33	5.00	3.96	.47	Agree
Reliability	2.40	5.00	3.36	.61	Agree
Responsiveness	2.25	5.00	3.77	.54	Agree
Assurance	3.00	5.00	4.19	.54	Agree
Empathy	2.60	5.00	3.98	.49	Agree
User Satisfaction	2.00	5.00	4.03	.53	Agree

Note: 2.60-3.39 as neutral, 3.40-4.19 as an agreement, and 4.20-5.00 strongly agree. As Table 4 displays that

The "Assurance" components have the highest mean equals 4.19. The lowest mean was observed in the "Reliability" component, which has a 3.36 mean.

### Correlation analysis

Correlation Analysis was used to test the level of correlation between two or more variables. The range of correlation values was between -1 to +1 (Pearson, 1926). When the values were closed in +1, there were strong positive correlations. Table 5 illustrates that Tangible, Reliable, Responsiveness, Assurance, and Empathy positively correlate with customer satisfaction. The

result reflects that the correlation between variables is significant ( $p < 0.01$ ), with the lowest value of 0.398\*\* and the highest value of 0.771\*\*.

Table 5: Correlation of constructs

Variables	T	R	RES	ASS	EM	US
Tangible	1					
Reliable	0.564**	1				
Responsive	0.655**	0.771**	1			
Assurance	0.496**	0.691**	0.576**	1		
Empathy	0.579**	0.685**	0.737**	0.677**	1	
Satisfaction Level	0.506**	0.439**	0.449**	0.398**	0.459**	1

\*. The correlation is significant at level 0.05. (2-tailed).

\*\*. There is a significant correlation at level 0.01. (2-tailed).

### Regression analysis

The statistical method is used for regression analysis to know the relationship between the dependent variable and more independent variables. In addition, it can be used to forecast an outcome variable and to measure the strength of the relationship between variables. The regression analysis result in SPSS is as follows:

The ANOVA output was examined to check whether the proposed Model was feasible. Therefore, the analysis of variance in table 6 indicated that Tangibility, Reliability, Responsiveness, Assurance, and Empathy were statistically significant in explaining customer satisfaction. The result showed that the overall Model was significant ( $F = 17.506$ ,  $P \text{ value} = 0.000$ ). The following table is constructed to analyze each predictor individually and whether they are statistically significant.

Table 6: ANOVA

Model	Sum of Squares	df	Mean Square	F	Sig.
Regression	18.085	5	3.617	17.506	0.000
Residual	40.910	198	0.207		
Total	58.995	203			

Table 7 Beta coefficients and p-value demonstrated the impact of independent variables on dependent variables. The higher the absolute value of beta coefficients, the stronger the effect. The regression results confirmed Tangibility, Reliability, and Responsiveness. Assurance and Empathy have a significant and positive relationship with customer satisfaction. Their magnitudes are as follows: Tangibility (Beta = 0.506,  $p = 0.000$ ) majorly affects customer satisfaction. Reliability (Beta = 0.434,  $p = 0.000$ ) is found to have a significant effect on customer satisfaction. Responsiveness (Beta = 0.449,  $p = 0.000$ ) positively and significantly affects customer satisfaction. Assurance (Beta = 0.398,  $p = 0.000$ )

significantly affects customer satisfaction. Finally, the result is that Empathy (Beta = 0.459, p = 0.000) positively and significantly affects customer satisfaction.

Table 7: Regression Analysis

Model	Unstandardized Coefficients		Standardized Coefficients	t	Sig.
	B	Std. Error	Beta		
(Constant)	1.704	0.278		6.138	0.000
Tangible	0.581	0.070	0.506	8.348	0.000
Reliable	0.384	0.056	0.434	6.838	0.000
Responsive	0.449	0.063	0.449	7.141	0.000
Assurance	0.393	0.064	0.398	6.170	0.000
Empathy	0.502	0.068	0.459	7.350	0.000

### Hypotheses testing

Table 8 illustrates the summary result from all hypothesis testing since the first and second regression analyses. The result indicated that all five hypotheses were supported.

Table 8 Hypotheses result

Hypotheses	Sig.	Result
H1: Tangibility has a significant relationship with the customer satisfaction.	.000**	Supported
H2: Reliability has a significant relationship with the customer satisfaction.	.000**	Supported
H3: Responsiveness has a significant relationship with customer satisfaction.	.000**	Supported
H4: Assurance has a significant relationship with the customer satisfaction.	.000**	Supported
H5: Empathy has a significant relationship with the customer satisfaction.	.000**	Supported

### Discussions of key findings

The research study's findings indicated that the five dimensions of quality of service (Tangibility, Reliability, Responsiveness, Responsiveness, and Empathy) have a significant relationship with customer satisfaction. First, Tangibility (Beta = 0.506, p = 0.000) significantly relates to customer satisfaction. The study of the Impact of Service Quality on customer satisfaction of ATM service: in Vietnam by Phan & Nham (2015), a case study of a Private Commercial Joint Stock Bank, described that the quality of ATMs (excellent design and suitable size), physical facilities equipment of transactions such as always-clear computer display screen, convenient and easy identification of the teller (ATM machinery) are the factors that create satisfaction of customers over the service. Among them, quality criteria, appearance, and design of cards are highly evaluated as they are appropriate for use in dynamic and modern life. Furthermore, the display screen machinery also affects the Bank's service quality (Nham, 2015). This finding has also been corroborated by other research, including Service Quality of Automated Teller Machines and Customer Satisfaction: (Mohammad & Alhamadani, 2011); Akpan (2016); Belay and Kindie (2017); Prasad (2018);(Nshimiyimana, 2020).

The second dimension of ATM service quality is Reliability. The result of this study revealed that Reliability (Beta = 0.434,  $p = 0.000$ ) is found to have a significant relationship with customer satisfaction. The studies of Akinmayowa et al. (2014) demonstrated that the feature of Reliability described the ability to perform the required service accurately and dependably at all times. ATM users want to receive the correct quantity and quality of service at all times, as promised by the banks. In addition, they prefer accurate billing of their accounts; they want user-friendly ATMs, fast ATMs, ATMs that do not run out of cash, ATMs that are not out of order, and no long queues at ATMs (Akinmayowa et al., 2014). Similarly, previous studies like Service Quality of Automated Teller Machine and Customer Satisfaction: Al-Hawari & Ward (2006), (Khan, 2010), (Wasswa Katono, 2011) found the same finding.

The third dimension of ATM service quality is Responsiveness. The result of this study illustrated that Responsiveness (Beta = 0.449,  $p = 0.000$ ) has a significant relationship with customer satisfaction. The studies of (Akinmayowa & Ogbeide, 2014) once again identified that the responsiveness aspect of ATM service quality relates to the ability of the bank staff to provide the agreed services timely, accurately, dependably, and promptly. Responsiveness measures the extent to which the banks put measures in place to recover services when ATM services are negatively confirmed, to respond quickly to requests and suggestions, and to assist customers in case of problems. A quick response to requests is likely to increase perceived convenience and diminish uncertainty, and the banks need to show that they are customer oriented and act benevolently toward customers (Akinmayowa & Ogbeide, 2014). This finding was the same as other studies, which included: Narteh (2015) and Prasad (2018).

In addition, Assurance was also an essential dimension of the ATM service quality. This research study showed that Assurance (Beta = 0.398,  $p = 0.000$ ) is significantly related to customer satisfaction. The study of Tazreen (2012) highlighted that Assurance is the knowledge of employees and the ability to convey trust and confidence. This finding was similar to other studies, which included: (Prakoso et al., 2017), (Mwatsika, 2016) and (Suleiman & Abdulkadir, 2022).

Lastly, Empathy (Beta = 0.459,  $p = 0.000$ ) has a significant relationship with customer satisfaction. The study by Siddiqi (2011) determined that customer service often has expectations about the extent to which the service provider appears to understand and be concerned about their needs and wants. The more service provider can see from the customer's point of view, the better. Employee and customer interactions are reflected through the empathy dimensions. Furthermore, bank customers seek front-line staff who can understand their needs (Siddiqi, 2011). This finding has also been substantiated in other studies, which included (Pakurár et al., 2019) and (Ramya et al., 2019).



## 5. Conclusion and Suggestions

### *Conclusion*

To meet customer satisfaction, service quality is one of the core strategies for a competitive advantage for the banks. Different key strategies are being developed to compete in the banking sector. ATM service plays a role in banking services because Cambodian people have adjusted their habits from traditional banking services to digital banking services, according to ACLEDA Bank Plc. (2020). The study found that Tangibility, Reliability, Responsiveness, Assurance, and Empathy were statistically significant and positively correlated with customer satisfaction.

### *Implications of the study*

#### Theoretical implications

The studies of Mulder (2018) stated that the Service Quality Model, also known as the SERVQUAL Model, was established and implemented by Valarie Zeithmal, Parasuraman, and Leonard Berry in 1988. It is a method to capture and measure the service quality experienced by customers. Initially, the emphasis was on developing quality systems for product quality. Over time, enhancing the quality of relevant services has become tremendously important. Improved service quality could give the organization a competitive edge. The SERVQUAL Model's knowledge-based theory lies in the fact that the data show a crucial role for the contextual factor in facilitating the flow of knowledge among entrepreneurs. Therefore, this study is important for future scholars who may pursue further research in this field.

#### Implications for finance and banking

Based on the study, this research contributes to Cambodia's banking industry, enhancing service quality via ATMs. Furthermore, this study also facilitates bank and branch managers who improve customer satisfaction more effectively and efficiently.

### *Limitations and future research*

The study positively contributed to the Bank learning about factors affecting customer satisfaction with service quality. However, this study also has limitations. First, this research used a quantitative method. Therefore, future researchers should conduct a qualitative or mixed-method study. Second, the sample size of the research study is still small, and the scope of the study area was only in ACLEDA Bank, Phnom Penh City. In addition, the sample size for this study was 204, and the norm was 385. Therefore, it is recommended that the following study should be conducted in different geographical locations (urban and rural areas), the whole country, or regions. In addition, future research can be done in public or private sector banks

that provide ATM services. Third, this research used convenience sampling to measure the five dimensions of the SERVQUAL Model. Thus, future researcher may consider another method of sampling to obtain a better overview of the situation. Last but not least, the study mainly focused on how service quality impact on customer satisfaction while there are other factors which affect customer satisfaction. Therefore, future research should consider other factors that impact customer satisfaction to develop a better understanding of the situation.

## Reference

- ACLEDA Bank Plc. (2020). *ATM Network*.
- Adepoju, E. & Alhassan, B. (2010). Relationship between customer satisfaction and ATM use outcomes: A study of private bank customers in Germany. *The International Journal of Bank Marketing*, 4(5) 44-47.
- Ahmed, R. R., Vveinhardt, J., & Streimikiene, D. (2017). Interactive digital media and impact of customer attitude and technology on brand awareness: evidence from the South Asian countries. *Journal of Business Economics and Management*, 18(6), 1115–1134.
- Akinmayowa, J. T., & Ogbeide, D. O. (2014). Automated Teller Machine service quality and customer satisfaction in the Nigeria Banking Sector. *Covenant Journal of Business and Social Sciences (CJBSS)*, 65(1), 62–72.
- Akpan, S. J. (2016). The influence of atm service quality on customer Satisfaction in the banking sector of Nigeria. *Global Journal of Human Resource Management*, 4(5), 65–79.
- Al-Hawari, M., & Ward, T. (2006). The effect of automated service quality on Australian banks' financial performance and the mediating role of customer satisfaction. *Marketing Intelligence & Planning*, 24(2), 127–147.
- Anderson, E. W., Fornell, C., & Lehmann, D. R. (1994). Customer satisfaction, market share, and profitability: Findings from Sweden. *Journal of Marketing*, 58(3), 53–66.
- Cengiz, E. (2010). Measuring customer satisfaction: must or not. *Journal of Naval Science and Engineering*, 6(2), 76–88.
- Considerations, E. (2018). *Individual Assignment 3* (pp. 2017–2018).
- COOPER, D. R., & SCHINDLER, P. S. (2011). *Business Research Methods. 11th Edition*, McGraw Hill, Boston.
- Grönroos, C. (1990). *Service management and marketing* (Vol. 27). Lexington books Lexington, MA.
- Iberahim, H., Taufik, N. K. M., Adzmir, A. S. M., & Saharuddin, H. (2016). Customer satisfaction on reliability and responsiveness of self service technology for retail banking services. *Procedia Economics and Finance*, 37, 13–20.
- Juneja, P. (2015). *Importance of Quality Management*. Retrieved from <https://managementstudyguide.com/importance-of-quality-management.htm>.

- Kagan, J. (2023). *What Is an ATM and How Does It Work?* Retrieved from <https://www.investopedia.com/terms/a/atm.asp>.
- Khan, M. A. (2010). An empirical study of automated teller machine service quality and customer satisfaction in Pakistani banks. *European Journal of Social Sciences*, 13(3), 333–344.
- Lewis, B. R., & Mitchell, V. W. (1990). Defining and measuring the quality of customer service. *Marketing Intelligence & Planning*, 8(6), 11–17.
- Lewis, R. C., & Booms, B. H. (1983). The marketing of service quality in emerging perspectives on service marketing. *Chicago, AMA*, 99–107.
- Lim, P. C., & Tang, N. K. H. (n.d.). Jackson. PM (1999). *An Innovative Framework for the Health*.
- Loke, S.-P., Taiwo, A. A., Salim, H. M., Downe, A. G., & Petronas, U. T. (2011). Service quality and customer satisfaction in a telecommunication service provider. *International Conference on Financial Management and Economics*, 11(2), 23–29.
- Magara, E. (2018). *The effect of automated teller machine use on customer satisfaction in banking: a case study of Stanbic Bank, Mbarara Branch*. Makerere University.
- Mohammad, A. A. S., & Alhamadani, S. Y. M. (2011). Service quality perspectives and customer satisfaction in commercial banks working in Jordan. *Middle Eastern Finance and Economics*, 14(1), 60–72.
- Mwatsika, C. (2016). Factors Influencing Customer Satisfaction with ATM Banking. *International Journal of Academic Research in Business and Social Sciences*, 6(2). <https://doi.org/10.6007/ijarbss/v6-i2/2002>
- Narteh, B. (2015). Perceived service quality and satisfaction of self-service technology: The case of automated teller machines. *International Journal of Quality & Reliability Management*.
- Nham, P. &. (2015). [https://www.researchgate.net/publication/283707186\\_Impact\\_of\\_service\\_quality\\_on\\_customer\\_satisfaction\\_of\\_automated\\_teller\\_machine\\_service\\_case\\_study\\_of\\_a\\_private\\_commercial\\_joint\\_stock\\_bank\\_in\\_Vietnam](https://www.researchgate.net/publication/283707186_Impact_of_service_quality_on_customer_satisfaction_of_automated_teller_machine_service_case_study_of_a_private_commercial_joint_stock_bank_in_Vietnam).
- Nshimiyimana, A. (2020). The Mediating Effects of Customer Satisfaction in the Relationship between ATM Service Quality and Customer Loyalty--A Case Study from Bank of Kigali. *European Journal of Business and Management Research*, 5(4).
- Pakurár, M., Haddad, H., Nagy, J., Popp, J., & Oláh, J. (2019). The service quality dimensions that affect customer satisfaction in the Jordanian banking sector. *Sustainability*, 11(4), 1113.
- Parasuraman, A., Zeithaml, V. A., & Berry, L. (1988). SERVQUAL: A multiple-item scale for measuring consumer perceptions of service quality. *1988*, 64(1), 12–40.
- Parasuraman, A., Zeithaml, V. A., & Berry, L. L. (1985). A Conceptual Model of Service Quality and Its Implications for Future Research. *Journal of Marketing*, 49(4), 41. <https://doi.org/10.2307/1251430>

- Prakoso, A. F., Nurul, R., Wulandari, A., Trisnawati, N., Fitriyati, D., Rachmawati, L., & Andriansyah, E. H. (2017). Reliability, responsiveness, assurance, empathy, and tangible: Still can satisfy the customer. *International Journal of Business and Management Invention*, 6(3), 68–75.
- Prasad, R. (2018). Service Quality of Automated Teller Machine and Customer Satisfaction: A Case Study of State Bank of India, Patna (Bihar). *International Journal of Management Studies*, 4(5), 26–34.
- Ramya, N., Kowsalya, A., & Dharanipriya, K. (2019). Service quality and its dimensions. *EPRA International Journal of Research & Development*, 4(2), 38–41.
- Robinson, S. (1999). Measuring service quality: current thinking and future requirements. *Marketing Intelligence & Planning*, 17(1), 21–32.
- Rust, R. T., & Zahorik, A. J. (1993). Customer satisfaction, customer retention, and market share. *Journal of Retailing*, 69(2), 193–215.
- Schindler, P. (2019). *Business Research Methods. 13th Ed. New York, USA: McGraw- Hill Higher Education.*
- Siddiqi, K. O. (2011). Interrelations between service quality attributes, customer satisfaction and customer loyalty in the retail banking sector in Bangladesh. *International Journal of Business and Management*, 6(3), 12.
- Suleiman, Y., & Abdulkadir, Y. (2022). Bank ATM users' perceptions towards ATM service quality: A structural equation modelling approach. *International Journal of Research and Innovation in Social Science (IJRISS)*, 6(5), 140–145.
- Taing, C., Duch, N., & Phoeun, M. (2021). The Impact of Digital Transformation on the Use of Banking Services. *AIB Research Series*, 1.
- Wasswa Katono, I. (2011). Student evaluation of e-service quality criteria in Uganda: the case of automatic teller machines. *International Journal of Emerging Markets*, 6(3), 200–216.
- Yamane, T. (1967). *Statistics: An introductory analysis*, (2nd ed.), Harper and Row, New York.

## The Impact of Service Quality Dimensions on Customers' Satisfaction to Use Debit Cards in Phnom Penh City

Keo Kriss, Sovuthiroth Hean, Chanvorleak Nhem, and Sokha Norng

Corresponding Author: krisskeo2@gmail.com

ACLEDA INSTITUTE OF BUSINESS, Phnom Penh, Cambodia

### ABSTRACT

*In the new industrial revolution 4.0 era, a debit card has been developed as a payment method that facilitates users in performing financial transactions via a light plastic card with low risk from cash holding and time-saving in visiting the bank. The study attempts to investigate the impact of the service quality dimension on customers' satisfaction with debit card usage. The study employed quantitative approach, using a questionnaire to collect data from 243 debit card holders who are currently living in Phnom Penh City. By using multiple regression analysis, the study has found that Tangibles, Responsiveness, and Assurance had a positive and significant impact on customers' satisfaction of using debit cards, while reliability and empathy was not statistically significant.*

**Keywords:** SERVQUAL Model, customers' satisfaction, debit cards

## 1. Introduction

With the advancement of technology, the banking industry has been upgrading itself to respond to the economic integration with modern banking services. Banks are able to offer customers a variety of electronic banking services with less time taken through an electronic payment system. In the early 2020s, due to the outbreak of Covid-19, customers were strongly encouraged to adopt the electronic payment method to reduce the risk of possible virus infection through cash. The advent of the advanced technology and electronic communication has brought about a wide range of electronic payment methods to serve customers. Qataweh, Aldhmour and Alfugara (2015) assert that an electronic payment system (EPS) usually refers to an online payment transaction. This payment was a debit card, a magnetically encoded plastic card, which could replace the payment made by cash or cheques in most retail transactions (Caskey et al., 1994).

The banking sector in Cambodia has witnessed a new financial infrastructure throughout Phnom Penh City and provinces in which 341 new branches have been opened and equipped with 519 new Automated Teller Machines (ATMs) and 22,928 Point of Sale (POS). With the Fintech Development, there have been 47 commercial banks governed by the National Bank of Cambodia (NBC) and authorized to issue debit and credit cards. This has resulted in a remarkable increase in cash-substitutional-card transactions, by which the number of credit and debit cards reached 67,968 and 2,759,453 respectively (NBC, 2020).

The availability of debit cards has been known as the crucial aspect of a convenient payment method, which has enabled customers to have a remote access to their bank accounts. Debit cards have brought about great advantages for customers, resulting in such a remarkable growth and change. Notably, the adoption of debit cards provides customers with convenience and cashless payments, leading them to a new living habit with digital platforms. Foscht et al. (2010) have found that the opportunity cost and risk related to carrying cash around were reduced through this payment method.

The advanced technological innovation in the banking industry has made payment methods, namely mobile banking payment, electronic payment cards, and virtual cards, become convenient for people in their daily lives. Among the population of 16 million in Cambodia in 2020 (Association of South-East Asian Nations [ASEAN], 2021), approximately 2 million people consumed debit cards (NBC, 2020).

Noticeably, research has been conducted centring around the issue of debit card usage due to the remarkable increase in the use of debit card service. Ly et al. (2021) adopted the Unified Theory of Acceptance and Use of Technology (UTAUT) to examine consumers' attitudes toward the use of debit cards. Truong et al. (2020) investigated this issue and found that the

rising number of customers' dissatisfaction with complaints and inconvenience toward debit card services led to a change of service providers. This current study aims to examine the impact of the service quality dimensions on customers' satisfaction of using debit cards in Cambodia since the debit payment is considered a crucial payment method, widely used in Cambodia particularly during the Covid-19 pandemic.

The current study sheds light on customers' satisfaction of this electronic payment to the financial and banking industry and clients. Firstly, this study will help inform the banks about the effectiveness of debit card payments and how consumers think and what they want from this service so that they can effectively work out how to improve the payment service quality. Secondly, this study benefits the consumers in being well aware when consuming this electric payment method. Finally, it contributes to the advancement of knowledge in the field of banking and finance.

## **2. Literature Review**

### *Definition of debit cards*

According to Caskey et al. (1994), debit cards are machine-readable, magnetically encoded plastic cards; their appearance is comparable to credit cards or cards used to access ATMs. It is a real-time electronic transfer between merchant and customer bank accounts. A debit card, a type of payment method, requires consumers to have the funds (or a line of credit attached to the account) in their account before a purchase transaction is completed. The payment amount made through a debit card is immediately deducted from the bank account and guarantees that cardholders do not spend beyond the amount in their account (Foscht et al., 2010).

### *The SERVQUAL Model on debit card usage*

SERVQUAL Model, known as Service Quality Model, has been described as the form of a discrepancy between customers' perceptions of services offered by particular firms and results from a comparison of their expectations with the notions of performance (Parasuraman et al., 1988).

The SERVQUAL Model is a key tool in many studies in different service settings to measure the relationship between service quality, consumer satisfaction, and purchase intentions (Cronin Jr & Taylor, 1992); and E-banking services (Hammoud et al., 2018) and banking halls of ACLEDA Bank Plc. (Taing et al., 2021). Hence, this study proposes the analysis on the five dimensions of the SERVQUAL Model in order to measure customer satisfaction of using debit cards.

### *Hypothesis development*

Lin (2003) defines customer satisfaction as the objective outcome of a cognitive and affective evaluation of comparison between expectations to the actual perceived level of experienced performance. Biswas and Roy (2020) assert, "satisfaction as a psychological state resulting when the emotion surrounding disconfirmed expectations is coupled with the consumer's prior feelings about the consumption experience" (p.3). It is also perceived as the overall judgment of cumulative experience with service/product features that provide a pleasant level of consumption (Sureshchandar et al., 2002; Burböck, 2014).

### *Tangibles and customer satisfaction*

Tangibles are defined as those related to physical tools, including buildings, equipment, and the composition of personnel and technologies used to reach the customers (Parasuraman et al., 1985; Tazreen, 2012). The tangibles of debit card can be measured in terms of design, shape, size, and the look (Parasuraman et al., 1988; Phan & Nham, 2015). Moreover, previous studies found that tangibles had positive influences on customer satisfaction (Rahman et al., 2017; Pakurár et al., 2019; Tien et al., 2021). Therefore, the study proposes the following hypothesis.

H1: Tangibles have a significant positive effect on customers' satisfaction of debit card.

### *Reliability and customer satisfaction*

Tien et al. (2021) cited that reliability is the capacity to offer the promised service with the right attitude and in a timely manner, along with a strong commitment of the staff to keep their promise, knowledge, and skills. In banking sector, the reliability is a significant element of the core service quality in the bank as it is perceived as a "do it right first attitude" to build the first good impression between customers and service providers (Berry et al., 1994). The reliability of debit card service can be measured in terms of accurate performance, absence of complaints, and promise (Parasuraman et al., 1988; Phan & Nham, 2015). More importantly, it is evident that that reliability significantly impacted on customer satisfaction (Rahman et al., 2017; Pakurár et al., 2019; Tien et al., 2021). Therefore, the study proposes the following hypothesis.

H2: Reliability has a significant positive effect on customer satisfaction of debit card.

### *Responsiveness and customer satisfaction*

Tazreen (2012) defines responsiveness as willingness to assist customers and deliver prompt services. Phan and Nham (2015) refer responsiveness to as willingness or readiness of employees to help customers and provide services. In this sense, bank employees are willing to answer any questions, concerns, or issues of customers regarding the use of debit card. Also, previous studies found that responsiveness has a significant and positive influence on customer



satisfaction (Arokiasamy & Abdullah, 2013; Pakurár et al., 2019; Tien et al., 2021). Therefore, the study proposes the following hypothesis.

H3: Responsiveness has a significant positive effect on customer satisfaction of debit card.

#### *Assurance and customer satisfaction*

Phan and Nham (2015) define assurance as knowledge and courtesy of employees and their ability to convey trust and confidence. Parasuraman et al. (1988) assert that assurance is a substitution of courtesy, competence, credibility, and security in the original ten dimensions for calculating service quality. In banking sector, assurance is measured in terms of quick and efficient service delivery as well as a sound knowledge of addressing customers' inquiries with courtesy (Tazreen, 2012). Assurance has been found having the strongest impact on overall customer satisfaction which has led to positive word-of-mouth outcomes (Arasli et al., 2005; Arokiasamy & Abdullah, 2013; Pakurár et al., 2019). Therefore, the study proposes the following hypothesis.

H4: Assurance has a significant positive effect on customer satisfaction of debit card.

#### *Empathy and customer satisfaction*

Phan and Nham (2015) cited that empathy refers to individualized care and attention provided by the firms to its customers. Pakurár et al. (2019) have found that customers need to be treated as a priority by service providers. This dimension aims to keep customers continuing to use bank services (Lau et al., 2013). Previous studies have concluded that empathy had a significant influence on customer satisfaction (Arokiasamy & Abdullah, 2013; Pakurár et al., 2019; Tien et al., 2021). Hence, the study raises the following hypothesis.

H5: Empathy has a significant positive effect on customer satisfaction of debit card.

#### *Conceptual model on the study of debit card usage*

The following figure (figure 1) shows the conceptual model on the study of debit card, the study has formulated the following hypotheses.

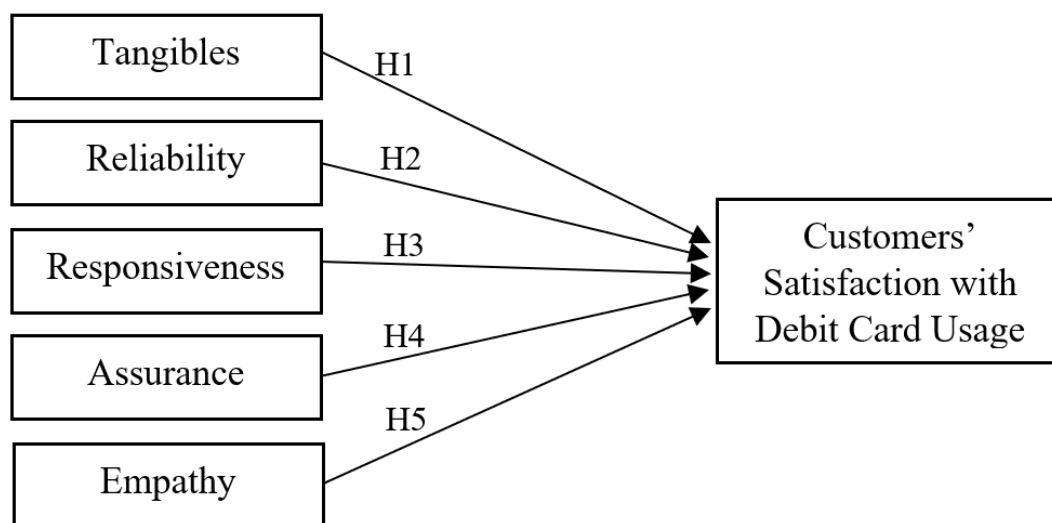

Figure 1: Conceptual model

### 3. Methods

#### *Research design*

This study applied the quantitative approach to test the proposed hypotheses. The study employed the SERVQUAL Model as a theoretical basis in order to develop the hypotheses. Then the study used the Model to develop a research tool to collect the data from the target participants, who frequently used debit cards.

#### *Sampling and sample frame*

The study collected data from debit card holders who are educators from three higher education institutions (HEIs) and employees from three small and medium sized enterprises (SMEs). These card holders' ages range from 15 to 64 who are currently living in Phnom Penh City. The site was selected because it is the largest cosmopolitan area in Cambodia. The name and contact lists of students who study in the evening from the three HEIs and employees from the three SMEs were obtained as the sample frame.

#### *Determine the sample size*

The participants were grouped in terms of gender, age, educational level, occupation status, and monthly income. For the best practice of regression analysis, the sample size was selected based on Green (1991), who determined that " $N > 50 + 8k$ "; and "k" represented the number of independent variables.

Formula:  $N > 50 + 8k$

When,

$N =$  Sample Size

$k =$  Number of independent variables

$N > 50 + 8(5)$

$N > 90$

Even though 90 is the appropriate sample size for five predictors in running the multiple regression analysis, the study collected up to 243 participants for validity of the findings.

### *Sampling procedure*

In order to avoid bias in data collection, this study used simple random, in which all the members of the population have an equal opportunity of being selected for the sample (Kumar, 2018). The name and contact lists were randomly selected by using Ms. EXCEL.

### *Research instrument*

The study designed a questionnaire by including the measurement of the five predictors and the outcome, such as customer satisfaction of using debit cards. The questionnaire was divided into four sections. Section 1 is comprised of demographic information. Section 2 consists of a screening question, the brand of debit cards, and debit card usage frequency. Section 3 is composed of the five dimensions of the SERVQUAL Model and customer satisfaction of the use of debit cards. The measurement of tangible, reliability, responsiveness, assurance, empathy were adapted from Phan and Nham (2015) and Parasuraman et al. (1988) and customer satisfaction was adapted from Mynuddin (2016) and Sikdar and Makkad (2015). The study used a 7-point Likert Scale as part of the measurement. Each scale was assigned with following meaning: 1 for Strongly dissatisfied, 2 for Dissatisfied, 3 for Somewhat Dissatisfied, 4 for Neutral, 5 for Somewhat satisfied, 6 for Satisfied, and 7 for Strongly satisfied. Section 4 includes open-ended questions were used to discover extra recommendations or any problems consumers encounter while using debit cards.

### *Data collection*

During the outbreak of COVID-19 in Cambodia, the questionnaire, designed in Google Form, was administered to debit card users at the selected HEIs and SMEs through social media, namely Facebook messenger and Telegram. The researchers precisely explained the objective of this study and screened individual participants to determine whether they are qualified as research participants in this study. The data were collected for three months from May to July 2022.

### *Data analysis*

The study employed both descriptive and inferential statistics in order to analyse the data obtained from the participants. The study analyzed the personal data, the brand of debit cards, and usage frequency by using descriptive statistics. Prior to running a multiple regression analysis, the study, first of all, calculated the mean by combining items into the variable so that the ordinal data become ratio ones. After that, the study ran Pearson correlation coefficient and analysis of variance to check model fitness. In order to test the hypothesis, the study grouped (tangibles, reliability, assurance, responsiveness, and empathy) as independent variables and customers' satisfaction as dependent variable.

The following figures show the multiple regression equation.

$$Y = \beta_0 + \beta_1X_1 + \beta_2X_2 + \beta_3X_3 + \beta_4X_4 + \beta_5X_5 + \epsilon$$

Where:

Y = customers' satisfaction as dependent variable

X1 = Tangibles as first independent variable

X2 = Reliability as second independent variable

X3 = Assurance as third independent variable

X4 = Responsiveness as fourth independent variable

X5 = Empathy as fifth independent variable

$\beta_0$  = intercept (value of Y when  $X_i = 0$ )

$\beta_1, \beta_2, \beta_3, \beta_4$  and  $\beta_5$  = are the coefficients of the five independent variables

$\epsilon$  = random error

### *Ethical consideration*

In the process of collecting data, the researchers did not force the participants to complete the questionnaire. In other words, they were expected to answer the questions on a voluntary basis. Confidentiality and anonymity of the participants' data were ensured in the study. The researchers did not manipulate the data in the analysis; in this sense, all the relevant data were presented and used in the analysis. Finally, the researcher gave full credit to other works in order to avoid plagiarism.

#### 4. Results and Discussions

##### *Demographic information*

The table 1 below shows that among 243 participants, debit card holders are mostly female, accounting for 56.4% and the age range from 15 to 25 years is 63%, which is the highest. Moreover, most of them hold a bachelor's degree and employees, accounting for 75.3% and 65.8%, respectively. Approximately 27% obtain a range of income from \$350 to \$399.

Table 1: Demographic information of the research participants

Item	Categories (N=243)	Frequency	Percentage
Gender	Female	137	56.4%
	Male	106	43.6%
Age	15-25 years old	153	63.0%
	26-35 years old	61	25.1%
	36-45 years old	22	9.1%
	46-55 years old	6	2.5%
	56-64 years old	1	0.4%
Educational Level	High School	22	9.1%
	Associate	7	2.9%
	Bachelor	183	75.3%
	Master	25	10.3%
	PHD	5	2.1%
	Others	1	0.4%
Occupation Status	Company/Organization/Employee	160	65.8%
	Government officer	6	2.5%
	Self-employed	26	10.7%
	Business owner	3	1.2%
	Currently unemployed	34	14.0%
	Others	14	5.8%
Monthly Income	Below or equal \$194	56	23.0%
	\$195 - \$349	61	25.1%
	\$350 - \$599	65	26.7%
	\$600 - \$999	34	14.0%
	Over \$1000	27	11.1%

### *Analysis of agreement level*

The table 2 below shows the level of agreement of each variable. Norng (2022) cited that by adopting the seven-point scale interpretation of (Armstrong, 1987), the mean score of 1.00-1.85 was regarded as Strongly Disagree, 1.86-2.71 as Disagree, 2.72-3.57 as Somewhat Disagree, 3.58-4.42 as Neutral, 4.43-5.28 as Somewhat Agree, 5.29-6.14 as Agree, 6.15-7.00 as Strongly Agree. The mean score of the six variables were 5.750, 5.732, 5.836, 5.570, 5.377, and 5.902 for Tangibles (TAN), Reliability (REL), Responsiveness (RES), Assurance (ASS), Empathy (EM), and Customer Satisfaction (CS), respectively. Therefore, card holders viewed all the constructs as at the Agree level.

Table 2: Level of Agreement

Variable	Minimum	Maximum	Mean	Std. Deviation	Level of Agreement
TAN	1.67	7.00	5.750	0.902	Agree
REL	2.75	7.00	5.732	0.903	Agree
RES	3.00	7.00	5.836	0.869	Agree
ASS	2.50	7.00	5.570	1.024	Agree
EM	1.75	7.00	5.377	1.141	Agree
CS	3.17	7.00	5.902	0.878	Agree

\*Note: Neutral: 3.58-4.42, Somewhat Agree: 4.43 – 5.28, Agree: 5.29 – 6.14, Strongly Agree: 6.15 – 7.00

### *Correlation analysis*

Pearson's correlation analysis measures the strength of the relationship between two variables. Lind et al. (2019) explains that the value of correlation (r) moving close to (-1) indicates a negative correlation, and that close to (+1) indicates a positive correlation between the two variables. Table 3 shows that the correlations of each pair of the constructs are positively correlated, and the strongest is between Reliability and Responsiveness at 0.740, while the lowest is between Customer Satisfaction and Empathy as 0.510.

Table 3: Pearson Correlation Matrix

Variable	TAN	REL	RES	ASS	EP	CS
TAN	1					
REL	0.662**	1				
RES	0.623**	0.740**	1			
ASS	0.579**	0.675**	0.643**	1		
EP	0.546**	0.638**	0.591**	0.758**	1	
CS	0.567**	0.633**	0.683**	0.612**	0.510**	1

\*\* . Correlation is significant at 0.01 level (2-tailed)

*Reliability test*

The study also checked the reliability, which measures the solidity and dependability of the instrument in testing the concept and assists the measuring of ‘goodness’ of the test (Cavana et al., 2001). In this sense, Cronbach’s Alpha was used to ascertain the internal consistency of each construct (Kumbhar, 2011). The result of the reliability test shows that the value of Cronbach’s Alpha went above 0.7, which was highly reliable (Nunnally, 1994). The lowest on was the Reliability construct, which stood at 0.767, and the highest one was the Empathy construct, which stood at 0.927.

Table 4: Reliability Test of Cronbach’s Alpha on Each Variable

No. of items	Variables	Cronbach Alpha (n=243)
3	TAN	0.789
4	REL	0.767
4	RES	0.759
4	ASS	0.868
4	EM	0.927
6	TAN	0.897

*Model fitness*

The analysis of the variance (ANOVA) shows that the proposed SERVQUAL Model was statistically significant at 0.000. Moreover, the model summary of linear regression analysis depicted R = 0.734, R square = 0.539, and Adjusted R Square = 0.529. These results show that the SERVQUAL Model was fit in the study of the debit card adoption.

*Variance inflation factor*

The study ran variance inflation factor (VIF) to check whether or not all independent variables are highly correlated, for it may interrupt the result of regression analysis. According to O’Brien (2007), VIF and tolerance are “both widely used measures of the degree of multicollinearity of the *ith* independent variable with other independent variables in a regression model” (p.673). When the VIF goes above 10, the regression coefficients are poorly estimated because multicollinearity exists; and when the VIF is near or above 5, there is a problem in multicollinearity in a multiple regression model (Akinwande et al., 2015). The following table 5 shows that the VIF ranged from 1.989 to 2.923; therefore, multicollinearity did not exist in this study because VIF of all independent variables were lower than 5.

Table 5: Collinearity statistics

Model	Tolerance	VIF
TAN	0.503	1.989
REL	0.341	2.932
RES	0.395	2.534
ASS	0.345	2.895
EM	0.390	2.563

*Multiple regression analysis*

The table 6 shows the impact of the five predictors on Customer Satisfaction with debit cards. As can be seen in Table 6, tangibles were statistically significant at .039 with the standardized coefficient  $\beta = 0.129$ . Moreover, Responsiveness and Assurance positively influenced Customer Satisfaction at  $\beta = 0.375$  and  $\beta = 0.244$ , respectively. However, Reliability and Empathy are not statistically significant.

Table 6: Result of Multiple Regression Analysis

Model	Unstandardized Coefficient		Standardized Coefficients	t	Sig.
	B	Std. Error	Beta		
(Constant)	1.250	0.288		4.338	0.000
TAN	0.126	0.061	0.129	2.079	0.039
REL	0.138	0.073	0.141	1.872	0.062
RES	0.379	0.071	0.375	5.341	0.000
ASS	0.210	0.064	0.244	3.258	0.001
EP	-0.044	0.054	-0.058	-0.818	0.414

Dependent Variable: CS

*Results of hypothesis testing*

Table 7 shows the summary results from the tested hypotheses obtained from the multiple regression analysis. The exhibition of backed results of H1, H3, and H4 at significant levels 0.039, 0.000 and 0.001, represented the independent variables, namely Tangibles, Responsiveness, and Assurance, respectively. Nevertheless, H2 and H5 were unsupported at the significant level of 0.062 and 0.414, respectively.

Table 7: Result of Hypothesis Testing

Hypothesis	Sig.	Result
TAN H1 Tangibles has a significant positive effect on customers' satisfaction.	.039	Supported
REL H2 Reliability has a significant positive effect on customers' satisfaction.	.062	Not Supported

(to be continued)



Table 7: Result of Hypothesis Testing

Hypothesis			Sig.	Result
RES	H3	Responsiveness has a significant positive effect on customers' satisfaction.	.000	Supported
ASS	H4	Assurance has a significant positive effect on customers' satisfaction.	.001	Supported
EP	H5	Empathy has a significant positive effect on customers' satisfaction.	.414	Not Supported

### Discussion

First of all, the impact of the tangibles at  $\beta = 0.129$ , responsiveness at  $\beta = 0.375$ , and assurance at  $\beta = 0.244$  on customer satisfaction were in line with the previous studies; for instance, the influence of tangibles and responsiveness on customer satisfaction supported (Rahman et al., 2017; Pakurár et al., 2019). Nonetheless, Meesala and Paul (2018) have found that the influence of tangibles on customer satisfaction was not supported. Moreover, the finding on the positive relationship between responsiveness and customer satisfaction contradicted (Wang & Shieh, 2006; Munusamy et al., 2010; Sanjuq, 2014).

Secondly, the effect of assurance on customer satisfaction was consistent with Phan and Nham (2015) and Pakurár et al. (2019); whereas it contradicted those of Rahman et al. (2017) and Meesala and Paul (2018). In other words, the current study has shown that debit card holders were satisfied with the plastic feature of debit cards, namely good quality design and physical look. They are more likely to value the prompt feedbacks from the bank staff in terms of effective communication, quick response to the questions and issues, and timely solutions. At the level of assurance, debit card users were also satisfied with the knowledge and courtesy of the bank staff in providing magnificent and proficient services, which increased their trust and confidence in debit card transactions.

Thirdly, the study has found that reliability does not affect Customers Satisfaction to use debit cards at  $\beta = 0.141$ . This finding contradicts the study of Mwatsika (2014) and Ha Nam Khanh (2019). Nevertheless, the result supports the study of (Munusamy et al., 2010; Sanjuq, 2014; Okeke et al., 2015). Regarding this relationship, the respondents viewed that they are satisfied with the process of using a debit card because they need to withdraw cashes from the ATMs and pay at the POS. Factor such as reliability does not influence their satisfaction with debit card usage.

Finally, the study has revealed that empathy did not have a significant positive effect on customer satisfaction at  $\beta = -0.058$ . The result supported the study of Munusamy et al. (2010); Sanjuq (2014); Meesala and Paul (2018). However, the result contradicted the studies of

Mwatsika (2014); Pakurár et al. (2019); Ha Nam Khanh (2019). This means that debit card holders were less likely satisfied with the attitudes of bank staff when listening to their inquiry and concern.

## **5. Conclusion and Implications**

### *Conclusion*

The primary objective of this study is to determine the impact of service quality dimensions on customer's satisfaction with debit cards at the commercial banks located in Phnom Penh. In order to address this objective, the study adopts the SERVQUAL Model as the conceptual framework to test five hypotheses. Based on the multiple regression analysis, the study has found that Tangibles, Responsiveness and Assurance have a significant and positive effect on Customer Satisfaction with debit cards, while Reliability and Empathy are not statistically significant.

### *Implications of the study*

The results of this study reveals that the SERVQUAL Model is one of the most appropriate frameworks to examine the bank products and services, especially the impact of service quality dimension on customer satisfaction with debit card. Nonetheless, the study suggests that the bank sectors might consider improving one part of the customer services continuously, namely active and empathetic listening.

The study also shows that debit card holders are satisfied with quality dimensions, such as Tangibles, Responsiveness, and Assurance. This implies that most part of the banks' customer services are satisfied by the debit card holders; therefore, banks might consider keeping these quality dimension alive; so that they can attract these existing customers to use other products and services.

### *Limitations and further research*

The sample size is considerably limited because the study was conducted only in the Phnom Penh City during the Covid-19 pandemic. In addition, the study only examines debit card adoption at the commercial banks. Therefore, the future research should consider looking into the behaviour of debit card holders at various provinces and at the specialized banks or the micro finance institutions. This study also focuses on post purchase behaviour such as customer satisfaction with debt cards, so the next study should examine the end spectrum of post purchase, namely customer loyalty.

## References

- Akinwande, M. O., Dikko, H. G., Samson, A., & others. (2015). Variance inflation factor: as a condition for the inclusion of suppressor variable (s) in regression analysis. *Open Journal of Statistics*, 5(07), 754.
- Arasli, H., Turan Katircioglu, S., & Mehtap-Smadi, S. (2005). A comparison of service quality in the banking industry: some evidence from Turkish-and Greek-speaking areas in Cyprus. *International Journal of Bank Marketing*, 23(7), 508–526.
- Armstrong, R. L. (1987). The Midpoint on a Five-Point Likert-Type Scale. *Perceptual and Motor Skills*, 64(2), 359–362. <https://doi.org/10.2466/pms.1987.64.2.359>
- Arokiasamy, A. R. A., & Abdullah, A. G. (2013). Service quality and customer satisfaction in the cellular telecommunication service provider in Malaysia. *Researchers World*, 4(2), 1.
- ASEAN. (2021). *ASEAN Statistical Yearbook 2021*. Retrieved from <https://www.aseanstats.org/publication/asyb-2021/>.
- Berry, L. L., Parasuraman, A., & Zeithaml, V. A. (1994). Improving service quality in America: lessons learned. *Academy of Management Perspectives*, 8(2), 32–45.
- Biswas, B., & Roy, S. K. (2020). Service quality, satisfaction and intention to use Union Digital Center in Bangladesh: The moderating effect of citizen participation. *Plos One*, 15(12), e0244609.
- Burböck, B. (2014). Prospect Theory and SERVQUAL. *Management (18544223)*, 9(2).
- Caskey, J. P., Sellon, G. H., & others. (1994). Is the debit card revolution finally here? *Economic Review-Federal Reserve Bank of Kansas City*, 79, 79.
- Cavana, R., Delahaye, B., & Sekeran, U. (2001). *Applied business research: Qualitative and quantitative methods*. John Wiley & Sons.
- Cronin Jr, J. J., & Taylor, S. A. (1992). Measuring service quality: a reexamination and extension. *Journal of Marketing*, 56(3), 55–68.
- Foscht, T., Maloles, C., Swoboda, B., & Chia, S.-L. (2010). Debit and credit card usage and satisfaction: who uses which and why--evidence from Austria. *International Journal of Bank Marketing*, 28(2), 150–165.
- Green S B. (1991). How Many Subjects Does It Take To Do A Regression Analysis. *Multivariate Behavioral Research*, 26(3), 499–510. <https://doi.org/10.1207/s15327906mbr2603>
- Ha Nam Khanh, G. (2019). Customer satisfaction towards ATM services: a case of

- Vietcombank Vinh Long, Vietnam. *Ha Nam Khanh Giao/Journal of Asian Finance, Economics and Business*, 6, 141–148.
- Hammoud, J., Bizri, R. M., & El Baba, I. (2018). The impact of e-banking service quality on customer satisfaction: Evidence from the Lebanese banking sector. *Sage Open*, 8(3), 2158244018790633.
- Kumar, R. (2018). *Research methodology: A step-by-step guide for beginners*. Sage.
- Kumbhar, V. M. (2011). Factors affecting the customer satisfaction in e-banking: Some evidences form Indian banks. *Management Research & Practice*, 3(4).
- Lau, M. M., Cheung, R., Lam, A. Y. C., & Chu, Y. T. (2013). Measuring service quality in the banking industry: a Hong Kong based study. *Contemporary Management Research*, 9(3).
- Lin, C. C. (2003). A critical appraisal of customer satisfaction and e-commerce. *Managerial Auditing Journal*, 18(3), 202–212.
- Ly, S., Keo, R., & Thab, C. (2021). Consumers' Attitudes toward the Use of Debit Card of Commercial Banks in Cambodia. *AIB Research Series, Volume 1*.
- Meesala, A., & Paul, J. (2018). Service quality, consumer satisfaction and loyalty in hospitals: Thinking for the future. *Journal of Retailing and Consumer Services*, 40, 261–269.
- Munusamy, J., Chelliah, S., & Mun, H. W. (2010). Service quality delivery and its impact on customer satisfaction in the banking sector in Malaysia. *International Journal of Innovation, Management and Technology*, 1(4), 398.
- Mwatsika, C. (2014). Customers satisfaction with ATM banking in Malawi. *African Journal of Business Management*, 8(7), 218–227.
- Mynuddin, M. (2016). Debit Card Adoption Attributes and Customer Satisfaction: A Study on Dutch-Bangla Band Ltd. *Journal of Business and Technology (Dhaka)*, 129–140.
- NationalBankofCambodia. (2020). *Annual Supervision Report 2020*. Retrieved from [https://www.nbc.org.kh/download\\_files/supervision/sup\\_an\\_rep\\_eng/EN\\_Annual\\_Report\\_2020.pdf](https://www.nbc.org.kh/download_files/supervision/sup_an_rep_eng/EN_Annual_Report_2020.pdf).
- Norng, S. (2022). Factors Influencing Mobile Banking Adoption in Cambodia: The Structuring of TAM, DIT, and Trust with TPB. Unpublished Ph.D dissertation. Phnom Penh. *Asian Journal of Business Research*, 12(3), 21–42. <https://doi.org/10.14707/ajbr.220133>
- Nunnally, J. C. (1994). *Psychometric theory 3E*. Tata McGraw-hill education.
- O'brien, R. M. (2007). A caution regarding rules of thumb for variance inflation factors. *Quality & Quantity*, 41(5), 673–690.

- Okeke, T. C., Ezech, G. A., & Ugochukwu, N. O. A. (2015). Service quality dimensions and customer satisfaction with online services of Nigerian banks. *The Journal of Internet Banking and Commerce*, 20(3).
- Pakurár, M., Haddad, H., Nagy, J., Popp, J., & Oláh, J. (2019). The service quality dimensions that affect customer satisfaction in the Jordanian banking sector. *Sustainability*, 11(4), 1113.
- Parasuraman, A., Zeithaml, V. A., & Berry, L. (1988). SERVQUAL: A multiple-item scale for measuring consumer perceptions of service quality. *1988*, 64(1), 12–40.
- Parasuraman, A., Zeithaml, V. A., & Berry, L. L. (1985). A Conceptual Model of Service Quality and Its Implications for Future Research. *Journal of Marketing*, 49(4), 41. <https://doi.org/10.2307/1251430>
- Phan, C., & Nham, P. (2015). Impact of service quality on customer satisfaction of automated teller machine service: case study of a private commercial joint stock bank in Vietnam. *Business: Theory and Practice*, 16, 280.
- Qatawneh, A. M., Aldhmour, F. M., & Alfugara, S. M. (2015). The adoption of electronic payment system (EPS) in Jordan: case study of orange telecommunication company. *Journal of Business and Management*, 6(22), 139–148.
- Rahman, A., Hasan, M., & Mia, M. A. (2017). Mobile banking service quality and customer satisfaction in Bangladesh: An analysis. *The Cost and Management*, 45(2), 25–32.
- Sanjuq, G. (2014). The impact of service quality delivery on customer satisfaction in the banking sector in Riyadh, Saudi Arabia. *International Journal of Business Administration*, 5(4), 77.
- Sikdar, P., & Makkad, M. (2015). Online banking adoption: A factor validation and satisfaction causation study in the context of Indian banking customers. *International Journal of Bank Marketing*, 33(6), 760–785.
- Sureshchandar, G. S., Rajendran, C., & Anantharaman, R. N. (2002). The relationship between service quality and customer satisfaction--a factor specific approach. *Journal of Services Marketing*.
- Taing, C., Duch, N., & Phoeun, M. (2021). The Impact of Digital Transformation on the Use of Banking Services. *AIB Research Series*, 1.
- Tazreen, S. (2012). An empirical study of SERVQUAL as a tool for service quality measurement. *Journal of Business and Management*, 1(5), 9–19.
- Tien, N. H., Anh, N., Dung, H., On, P., Anh, V., Dat, N., & Tam, B. (2021). Factors impacting

- customer satisfaction at Vietcombank in Vietnam. *Hmlyan J. Econ. Bus. Manag*, 2, 44–51.
- Truong, T., Phan, H., & Tran, M. (2020). A study on customer satisfaction on debit cards: The case of Vietnam. *Uncertain Supply Chain Management*, 8(2), 241–251.
- Wang, I.-M., & Shieh, C.-J. (2006). The relationship between service quality and customer satisfaction: the example of CJCU library. *Journal of Information and Optimization Sciences*, 27(1), 193–209.

## The Impact of Self-Service Banking Quality on Customer Satisfaction: Evidence from ACLEDA Bank Plc.

Chanpov Ou, Evanuk Sarath, Muniroth Vorn, and Phorn Ngam

Corresponding Author. Email: chanpovou9999@gmail.com  
ACLEDA INSTITUTE OF BUSINESS, Phnom Penh, Cambodia

### ABSTRACT

*Developments in information and communication technology are radically changing the way of business. The technological developments have resulted in new delivery banking products and services known as self-service banking. However, since it is a new service in Cambodia, it leads to practical issues, especially after experiencing the service. Hence, this research identifies and investigates the impact of self-service banking quality on customer satisfaction. The study integrated security and perceived benefits with a SERVQUAL model and used a questionnaire to collect data from 265 respondents who experienced using self-service banking. By using multiple regression analysis, the study found that tangibility, empathy, and perceived benefits were fully supported and significantly positively affected customer satisfaction, whereas reliability, responsiveness, and security did not influence customer satisfaction with self-service banking. The study showed results that Tangibility, Reliability, Responsiveness, Empathy, and Perceived Benefit influence customers' behavioral intention, so banks should focus on these factors to increase the level of self-service banking satisfaction. In order to fulfill customer satisfaction, banks should actively follow the trend of technology and renovation. Then the customers will come and spread their experience of using self-service banking.*

**Keywords:** Self-service Banking, Customer Satisfaction, SERVQUAL Model, Security, Perceived Benefits

## 1. Introduction

Nowadays, almost all commercial public, private, or foreign national banks offer automated self-service banking services. As the products offered by the banks are more or less identical, banks are trying to have an edge over rivals on other parameters, which may enhance customer satisfaction and loyalty. Almost every bank is now using technology to deliver services to customers. With time automated banking services acceptance is increasing among bank customers, leading to the reduction in transactions through branches and the increase in transactions via automatic self-service modes in many banks.

Retail banks usually employ numerous self-service channels to reach customers, including Automated Teller Machines ATMs, Automated Telephone Banking, Web Banking, Short Message Service (SMS) Banking, and Kiosks. Notably, banks deploy several different channels to deliver their services to customers, and therefore these service channels play an essential role in consumer interactions with retail banks. Service organizations, including retail, are motivated by efficiency gains, flexibility, productivity, and improved corporate performance (Dabholkar, 1996). As cited by Madhusanka, (2018), it is necessary to understand the customer evaluation of these multiple service channels to improve the organizational status, especially in banks, and customer satisfaction in a dynamic competitive environment (Orel & Kara, 2014). Some customers prefer personal interaction with service personnel and other customers and are less than eager or could even resist using self-service banking. Self-service banking is viable for banks and other financial intermediaries because information processing is essential to their services (Charles, 2015).

Self-service banking has been offered by many banks in Cambodia; for instance, ACLEDA Bank Plc. provides an efficient delivery ecosystem across the Kingdom comprising ATMs, self-service banking outlets, cash deposit, cash withdrawal machines, virtual teller machines (to open accounts and print cards), and term deposit machines (for fixed deposits), all of these serve as a powerful catalyst for the next wave of growth (Phnom Penh Post, 2022).

To keep up to date with technology and meet customer satisfaction, ACLEDA Bank Plc. has successfully invented a new digital banking service called Self-Service Banking. It allows customers to perform and conduct transactions independently instead of getting directly to the bank. Even if self-service banking keeps up with technology, its usage could be improved. Since it is a new service in Cambodia, it leads to some practical issues, and more people need to learn about its existence. Hence, this study aims to illustrate the impact of self-service quality on customer satisfaction by getting evidence from ACLEDA Bank Plc.

The objective of this research study is to analyze the impact of self-service banking quality on customer satisfaction and apply a SERVQUAL Model to measure six hypotheses. The study



also aims to determine the impact of tangibility, reliability, responsiveness, empathy, security, and perceived benefits on customer satisfaction of self-service banking.

In addition, this study aims to gather evidence from the self-service banking of ACLEDA Bank in Cambodia. The study will also identify the impact of self-service banking quality on customer satisfaction. It focuses on some key factors such as tangibility, reliability, responsiveness, and perceived benefits. This study will significantly benefit Cambodia's banking industry by providing insights into how to enhance its self-service banking quality. Finally, this study will contribute to future research and the literature on self-service banking quality, particularly within the Cambodian context.

## 2. Literature Review

### *Definitions of self-service banking*

Self-service banking is the use of self-service technologies in banking. Examples of self-service banking include banking by telephone and the Internet, EFTPOS (Electronic Funds Transfer at Point of Sale) terminals, automated teller machine, and other interactive kiosks (Sannes, 2001). The term 'self-service technologies' was first used by Meuter, (2000); they defined self-service technology as 'technological interfaces that enable customers to produce a service independent of direct service of employee involvement" (p.67-68).

Self-service banking refers to the banking service where the customers conduct such financial transactions as deposit and withdrawal, inquiry, transfer, bill payment, loans, currency exchange, and wealth management through self-service equipment. Campbell & Frei (2010) Instead of going into a branch, customers can control their finances 24/7 using the following self-service channels: ATMs—cellphone banking (on any cellphone) Meuter, (2000).

Self Service banking is an alternative for banks to cater to withdrawal and deposit of cash, besides over-the-counter transactions. The emergence of ATM and other new forms of banking have accelerated banks' requirement to dwell on service quality for customers' satisfaction and retaining loyalty. Adzmir & Taufik (2016) The introduction of self-service banking to the delivery of a service has led to the removal of the provider's personnel from the transaction and gave the customer more responsibilities to the customer to transact the service on their own. (ACLEDA Bank, 2021)

### *Self-service banking of ACLEDA Bank Plc.*

ACLEDA Bank Plc is the largest bank in Cambodia, offering a wide range of financial and self-service banking products. Any self-service banking in ACLEDA Banking Plc. is established to support customers and provide the best service technologically. All ACLEDA

Bank branches have all self-service machines both in the city and province; it had 993 ATMs in Cambodia, including AIMS in the Branch and public place ATMs in 2021.

Self-service banking's technical and digital service has many functions and has been established since 2003. For machines, at ACLEDA, there are ATMs, ATM deposit machines, ATM POS machines, And Virtual Teller Machines. Customers can use all these machines anywhere and whatever they want 24/7.

ACLEDA ATM and deposit machines allow the operation of banking services via ACLEDA cards and other banks' cards at any time (24/7) safely and conveniently. ACLEDA POS is an electronic machine for use with ACLEDA cards or other banks' cards to pay for goods or services instead of cash safely and conveniently, and Term Deposit Machine is a Self Service Banking of ACLEDA Bank Plc. Providing customers with term deposit opening and certificate printing by themselves at all times, VIRTUAL Teller Machine can open a customer's bank account by themselves with Virtual Teller Machine (VTM) anytime and quickly (Key Industry, 2018).

#### *SERVQUAL Model*

SERVQUAL model is the service quality model used for measuring service quality and customer satisfaction. American marketing gurus Valarie Zeithaml, Leonard Berry, and Parasuraman suggested this SERVQUAL model in 1988 to analyze dimensions of service quality and perceptions of service quality. This elaborative model helps bridge the gap between customer expectations and needs. The current five dimensions of the SERVQUAL model are used to measure service quality. While the SERVQUAL model had ten dimensions, its simplified model - the RATER model, has five parameters under which the customer evaluation is measured. (Parasuraman, 1988). They are understood as service quality dimensions used to find out perceived service quality on the multiple-item scale. (Parasuraman, 1988). First, reliability is the ability of the firm to perform the service effectively and accurately. It measures whether the firm lived to its promises or not. Second, assurance depends on the employees of the firm. Their skill is to produce trust and credibility in the consumer's minds. It requires proper knowledge and dedication. The third is tangibility, which refers to physical facilities, equipment, personnel, and communication material. Empathy refers to the attention and priority the organization gives to the customers' needs and requests.

Moreover, responsiveness relates to the firm's ability and willingness to aid customers and provide apt service as promised. It was initially measured considering ten components - responsiveness, reliability, competence, access, courtesy, communication, credibility, security, customer understanding, and tangibles (Parasuraman, 1988). The SERVQUAL Model is primarily a qualitative analysis. If a satisfaction survey mainly depends on the transactions

between supplier and buyer, the observed quality is measured through generic environmental factors ( Parasuraman et al., 1988).

SERVQUAL is a popular model for measuring service quality in the world. It was used in many types of research (Zhou, Hudson, & Hoa, 2007). The SERVQUAL model is initially designed for use in service firms and retailers. In reality, while most organizations will provide some form of customer service, only service industries are interested in understanding and measuring service quality. Therefore, SERVQUAL takes a broader service perspective beyond simple customer service. The most popular model for evaluating service quality is SERVQUAL, which has developed and has the attributes of tangibility, competency, courtesy, reliability, responsiveness, credibility, access, assurance, security, and understanding (Parasuraman, 1988). Some of these dimensions hugely positively affected customer satisfaction when using self-service banking. So, to find out the impact of self-service banking quality on customer satisfaction, SERVQUAL is the most suitable model for the present research study.

### *Conceptual framework of the study*

#### Customer satisfaction

Customer satisfaction is one of the essential concepts in marketing studies (Jamal, 2004). It links processes culminating in purchasing with post-purchase phenomena such as attitude change, repeat purchase, and brand loyalty (Churchill Jr & Surprenant, 1982). Oliver (1980) explains that satisfaction arises when customers compare their perceived product/service performance with expectations.

Several varying definitions are proposed to clarify customer satisfaction. However, most definitions commonly compare post-product/service performance with pre-formed expectations. Oliver (1981) defines satisfaction as an emotional post-consumption evaluative judgment concerning a product or service. Similarly, Tse and Wilton (1988) defined customer satisfaction as a "consumer response to the evaluation of the perceived difference between expectations and the final result after consumption"(p.46). As cited by Claude (2022), satisfaction can also be described as the feedback of a post-purchase assessment of a specific service/product's quality and compared with the expectation of the prior-purchasing stage (Kotler & Keller, 2011).

In contrast, other researchers have observed that the impact practiced within the purchasing and consuming stage of the product/service may also affect the customer's judgments toward satisfaction (Homburg, 2006). Thus, customer satisfaction is a customer's feeling of pleasure or displeasure after he or she has distinguished the performance of a product/service for his or her expectancy (Keller & Lehmann, 2006). Consistent with these definitions, and in so far

as this study is concerned, customer satisfaction is the customer's attitude formulated in response to using any form of Self-Service Banking. This research study uses SERVQUAL Model to apply and construct the measurement of customer satisfaction as it is one of the most widely used methods for evaluating the personal elements of customer service quality.

### *Conceptual model and hypotheses*

#### Tangibility

Tangibles are the appearance of physical facilities, equipment, personnel, and communication materials. (Parasuraman, Berry & Zeithaml 1991). This relates to the physical appearance of self-service banking. It appeals to the customer and is brightly lit at night. The surroundings are maintained clean by banks providing waste bins for litter generated from receipts (Parasuraman, 1988).

Customers will use the physical image of the service to assess quality. Tangibles are associated with the physical facilities, tools, and machines used to provide the service and representations of the services, such as statements, cards (debit and credit), speed, and efficiency of transactions (Parasuraman, 1985). Tangibility also defines as the degree to which a product or service portrays its clear concrete image and intangibility as the lack of physical evidence. Thus, cannibalizing services is a critical success path for services and industry (Reddy, 1993). The reliability dimension includes overdraft privileges (Agbor, 2011). Sultana & Das (2016) considered tangibles a distinct element, showing consistency across cultures.

H1: The tangibility of self-service banking has a significant positive effect on customer satisfaction.

#### Reliability

Reliability refers to the ability to deliver the expected standard at all times, how the organization handles customer services problems, performing the right services for the first time, providing services within the promised time, and maintaining error-free records. (Parasuraman, Berry & Zeithaml 1991). Reliability shows the ability to provide services accurately, on time, and credibly (Parasuraman et al., 1985). It measures whether the firm lived to its promises or not. This requires consistency in the implementation of services, respect for commitments, and keeping promises to customers. Parasuraman et al. (1985) stated that reliability means organizations perform a service correctly the first time. The ability to perform the promised service dependably and accurately. This relates to the ability to provide a service as customers expect in terms of speed (how quickly the transaction is performed), accuracy (how correct the transaction is in terms of money withdrawn), and if the equipment is operational 24 hours as expected—reliability of self-service banking which could inspire

customer satisfaction based on its promised and accuracy transaction provided. (Parasuraman, Berry & Zeithaml 1991).

H2: The reliability of self-service banking has a significant positive effect on customer satisfaction.

### Responsiveness

According to Madu & Madu (2002), responsiveness is the readiness to support the bank's customers and deliver them a rapid service. This kind of service can be shaped into four forms. First, the self-service banking system can control and operate the service properly. Second, self-service banking can guide customers toward proceeding correctly in case of failing operations. Third, it can also cover a rapid solution for any possible transaction error. Finally, it can support the customer's questions with on-the-spot responses.

The willingness to help customers and to provide prompt service. It helps customers to get when they bring forward self-service banking complaints such as accounts being debited at the same time money has not been dispensed, cards being captured underpayment, lack of certain currency denominations, no receipts being issued, and situations where the e-banking is out of service for very long hours and at times days. (Parasuraman, Berry & Zeithaml 1991). This is another area that needs attention as customers feel the service is below their expectations. Similarly, responsiveness is the willingness to help customers and provide services quickly (Kotler, 2012).

H3: The responsiveness of self-service banking has a significant positive effect on customer satisfaction.

### Empathy

Empathy is the caring and personalized attention the organization provides to its customers. Individual attention and convenient operating hours were the two primary elements that Parasuraman et al., 1991 included in their evaluation of empathy. The degree to which the customer feels empathy cause the customer to either accept or reject the service encounter. Empathy replaces access, communication, and understanding the customer in the original ten dimensions for evaluating service quality (Parasuraman et al., 1988). In addition, Parasuraman et al. (1985) indicated empathy: a willingness to care, providing personal attention to the customer to provide deep concern and specific service to each customer. In particular, prior research suggests that the facilities of self-service banking at the frontline' care for and attention to the customer engender customer satisfaction (Gorry & Westbrook, 2011; Tax et al., 1998) fostering alignment of feelings and thoughts between people and generating smooth, harmonious interactions (Bernieri, 1988; Gremler & Gwinner, 2008).

H4: The empathy of self-service banking has a significant positive effect on customer satisfaction.

### Security

Park & Kim, (2008) define security as the ability of online shop in controlling and guarding the transaction data. Moreover, Park and Kim (2006) states that the security guarantees play an important role in establishing trust to reduce consumer concern about the misuse of personal data and transaction data that can be easily damaged. When the level of security can accept and meet the expectations of consumers, then consumer maybe willing to open their personal information and will buy with a secure feeling. Security protects a customer's personal information from suspicious electronic transaction uses. Security is an essential factor that is considered seriously by online customers because it is one of the main factors when they decide to buy online. Gremler & Gwinner (2008) The issue of security has an essential role in developing trust during online transactions using self-service banking. It helps customers become more confident about the transaction and finally feels satisfied. In this context, the security of individual customers' deposits (managing the liquidity of a commercial bank) and their payments is crucial. Security of customers' deposits is the critical factor of success for banks as this factor heavily influences customer acquisition, retention, or loss. For this reason, a commercial bank as a business unit must undertake such measures to ensure proper and efficient protection of customers' deposits (Park & Kim, 2008).

H5: The security of self-service banking significantly positively affects customer satisfaction.

### Perceived benefits

Perceived benefits are also known as perceived usefulness. According to the Technology Acceptance Model (TAM), perceived usefulness is the degree to which a person believes using a particular system would enhance job performance. According to Davis (1989), perceived usefulness refers to consumers' perceptions regarding the outcome of the experience. Davis (1989) defined perceived usefulness as the individual's perception that using the new technology to enhance or improve her/his performance.

Similarly, Mathwick et al. (2002) defined perceived usefulness as the extent to which a person deems a particular system to boost his or her job performance. Perceived usefulness could be understood as people's judgment on whether their decision to use or implement a specific technology is advantageous for themselves (Tojib & Tsarenko, 2012; Stocchi et al., 2019; Wilson, 2019). According to Salihu (2019), suitable observation of self-service banking for customer satisfaction will make sense of the benefits of that service for conducting such transactions. To increase the adoption rate toward self-service quality, some certain reason was offered by Lee (2008), customers can gain great benefits from a wider range of financial

benefits, faster transaction speed, increased information transparency that can save time since self-service banking does not need a paper documents, the processing of which can give rise to errors and delays, and which also requires more personnel. Self-service banking helped customers to reduce waiting time and communicate with bank staff regarding on transaction detail. During the transaction, self-service banking allowed customers to control and monitor contractual performance at any time (Lee, 2008).

H6: The perceive benefit of self-service banking has a significant positive effect on customer satisfaction.

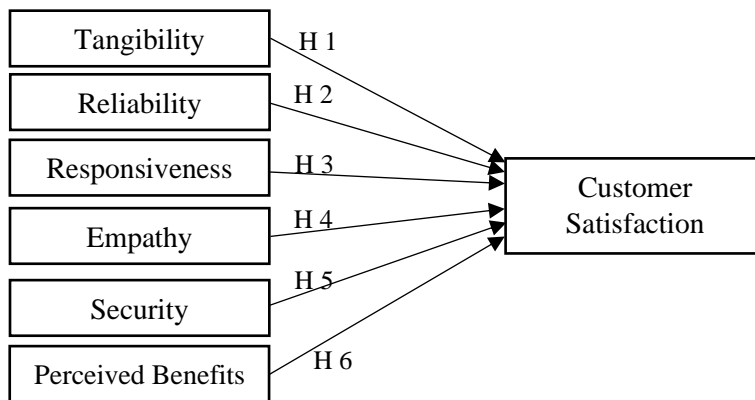

Figure 1: Conceptual model

Overall, this study employed the SERVQUAL Model to study the factors influencing customer satisfaction to adopt self-service banking in Cambodia. To set light on the study, the following six hypotheses have been proposed:

- H<sub>1</sub>: The tangibility of self-service banking has a significant positive effect on customer satisfaction.
- H<sub>2</sub>: The reliability of self-service banking has a significant positive effect on customer satisfaction.
- H<sub>3</sub>: The responsiveness of self-service banking has a significant positive effect on customer satisfaction.
- H<sub>4</sub>: The Empathy of self-service banking has a significant positive effect on customer satisfaction.
- H<sub>5</sub>: The Security of self-service banking has a significant positive effect on customer satisfaction.
- H<sub>6</sub>: The perceived benefit of self-service banking has a significant positive effect on customer satisfaction.

### 3. Method

#### *Research design*

This research study uses a quantitative method. Labaree (2009) defined quantitative methods as emphasizing objective measurements and the statistical, mathematical, or numerical analysis of data collected through polls, questionnaires, and surveys or by manipulating pre-existing statistical data using computational techniques. So, this study focused on researching some of the previous studies in the literature review to identify and construct measurements of the six hypotheses to create a questionnaire from each item. In order to answer the research question, the researcher developed the alignment of the research followed by data collection design, sampling design, and measurement questions.

#### *Research area and target population*

The study was conducted in Phnom Penh City and focused on students, employees, and stakeholders who experienced using self-service banking by using a survey questionnaire, which was sent through social media, such as Messenger, Facebook, and Telegram.

#### *Sample size*

The sample size was determined by formulas suggested by Green (1991) for determining the minimum of subjects required to conduct multiple regression analyses. The sample size was proposed:

$$N \geq 50 + 8P$$

Where:           - N is a sample size  
                       - P is the Number of predictors

Therefore,         $N \geq 50 + 8(6)$

So as assuming result there were  $N \geq 98$  respondents

Even though the calculated sample size was 98, the study attempted to collect at least 250 sample sizes. As a result, 265 respondents had participated in the study.

#### *Research tools*

In order to gather the data, the researcher collected survey questionnaires using Microsoft Forms. The questionnaire was designed into five sections which made respondents easy to understand when filling all their selection answers. The first section is an introduction part where the researcher introduces who they are or where they are from, especially either expressing the objective of conducting this survey along with the topic of the study. The second



section mainly asked about respondents' personal information, including gender, age, academic qualification, employment status, and the frequency of using self-service banking. In order to keep the respondent's privacy, the questionnaire did not ask for their name in the survey form. The third section measured the item of each independent variable by using a 7-point Likert scale in designing each questionnaire, while the fourth section used the same scales to measure customer satisfaction, which is the dependent variable in this study. The 7-point Likert scale was used because it reduced raters' error (Norng, 2022). In the last section, the researcher created a measurement question to ask respondents if they have any recommendation for improving self-service banking.

Table 1: Construct measurement of the seven variables

Constructs	Items	References
Tangibility	TAN 1: The environment of self-service Banking is clean. TAN 2: All facilities of self-service banking are modern.	(Parasuraman, 1985)
Reliability	R 1: Self-service banking provides a promised and accuracy transaction. R 2: Self-service banking provides customers a quick transaction (withdrawal, account management, money transaction in accordance with the new technology.	(Parasuraman, 1985)
Responsiveness	RES 1: All facilities of self-service banking are presentable & free from error. RES 2: Self-service banking is available 24/7 days.	(Mansoor, 2021) (Parasuraman, 1985)
Empathy	EMP 1: Self-service banking reduced customer waiting time & no more queues. EMP 2: The location of self-service banking is convenient.	(Parasuraman, 1985)
Security	SEC 1: Self-service banking provides security transaction. SEC 3: Self-service banking provides customer privacy.	(Parasuraman, 1985)
Perceived Benefit	PB 1: Self-service banking improves customer performance in making payment PB 2: Self-service banking allow customer to do self-check account balance and statement	(Bhattacherjee & Charles, 2014)
Customer Satisfaction	CS 2: I am satisfied with the service provided of self-service banking CS 4: I am satisfied with the security guard of self-service banking	(Nham, 2015)

### *Data collection*

Since the study used a quantitative method, the researcher collected the data as all primary data that focused on responses from the targeted sample. The data collection was gathered from the survey questionnaire through Microsoft Forms. The survey form was sent to some respondents who were closer to the researcher's hand and trusted sources who could complete the survey and

provide back valuable data for analysis. Moreover, the survey form was distributed through many social media platforms to those who had experience using self-service banking. Besides collecting data by using social media, the researcher also obtained a permission by AIB forwarding the survey to AIB's students and staffs, ACLEDA Bank's staffs, and Management currently staying in Phnom Penh.

*Data analysis method*

In order to test the hypothesis, the study ran a multiple regression analysis by grouping Tangibility, Reliability, Responsiveness, Empathy, Security, and Perceived Benefit as the independent variables, while Customer Satisfaction was assigned as the dependent variable.

*Reliability test*

Reliability is the extent to which an instrument will produce consistent results on similar subjects under similar conditions and can be assimilated with the precision of a certain measurement (Ursachi, 2015). Cronbach's Alpha coefficient confirmed the reliability of the data to ensure the internal consistency reliability for item scales. As cited in Vuong, (2019), the indicator typically ranges between zero and one, and the rates for comparison are the Cronbach's Alpha index, which can be acceptable if it is equal to or above 0.7 (Giao, 2019). It classified that the constructed variables and factors are reliable to be implemented in this research (Nunnally, 1994).

Table 2: Reliability Test of Cronbach’s Alpha on Each Variable

Nº	Item	Cronbach Alpha (n=265)
1	Customer Satisfaction	0.876
2	Tangibility	0.899
3	Reliability	0.915
4	Responsiveness	0.788
5	Empathy	0.844
6	Security	0.916
7	Perceived Benefit	0.939
	All variables	0.976

As shown in Table 2, each variable attains Cronbach Alpha value above 0.7 which indicates that these variables are statistically reliable with the lowest value at 0.788 for Responsiveness and highest value at 0.939 for Perceived Benefit. In addition, the combination of all variables statistically exceeds 0.9, which is considered excellent.

*Ethical considerations*

Ethical issues need to be considered during the formulation of the evaluation plan. Ethical considerations during evaluation include (Trochim, 2006):

- Respondents were fully informed about the evaluation being conducted.
- It was imperative that the evaluation process does not harm participants in any way (unintended or otherwise).
- Not deceive or target respondents' privacy.
- Making sure that all respondents volunteered and were not forced to do the thing.

**4. Results**

*Demographics information*

The data gathered from Microsoft Forms demonstrated that the gross sample of more than 311 respondents was collected. Unfortunately, the valid data were only 265. In Table 3, the results illustrated that among the 265 respondents, the accumulation of female respondents was 59% while male was 41%. Moreover, the highest selected age gap has shown that respondents who are 18-25 years old were at 42%, followed by the 27% of the aged 26-29 years old, while the remaining 19% is the aged 35-44 years old and 10% between 30-34 years old. 88% of the respondent were from Phnom Penh and 12% from the provinces. The researcher also asked about the background of respondents' academic qualifications, which illustrated that the highest data collected chiefly from bachelor's degrees, reaching 58%, 20% of master's degrees, 4% of associate degree while high school was only 1% and others 17%. In addition, 74% of the participants were from companies, banks, and schools, while 12% were business owners. In contrast, government officers and self-employed contributed 8% and 3%, respectively, while currently unemployed were 8%. Regarding the participants' income, the highest scale selected (46%) was between \$191 - \$499, followed by 40% between \$500-\$999, 8% between \$1000-\$1499, and 1% between \$1500-\$1999 and \$2000 or above. Additionally, the frequency of the use of self-service banking in terms of daily use was 48%, used once a week at 34%, and used twice a week was 11% compared to the user using twice a month at 7%. Lastly, the 265 respondents were all experienced using ACLEDA self-service banking.

Table 3: Demographic information of the respondents

Item	Categories (N=265)	Frequency	Percentage
Gender	Female	156	59%
	Male	109	41%
Age	18-25 years old	109	42%
	26-29 years old	72	27%
	30-34 years old	27	10%

(to be continued)

Table 3: Demographic information of the respondents (continued)

Item	Categories (N=265)	Frequency	Percentage
Age	35-44 years old	51	19%
	45-54 years old	6	2%
	55 years old or over	0	0%
Current Address	Phnom Penh	233	88%
	Province	32	12%
Qualification	Master's Degree	54	20%
	Bachelor's Degree	154	58%
	Associate Degree	11	4%
	High School	2	1%
	Other	44	17%
	Occupation	Company/ Bank / School employee	196
	Business Owner	32	12%
	Government Officer	21	8%
	Self-employed	8	3%
	Currently unemployed	8	3%
Salary Range	Below \$190	10	4%
	\$191 - \$499	123	46%
	\$500 - \$999	106	40%
	\$1000 - \$1499	22	8%
	\$1500 - \$1999	2	1%
	\$2000 or above	2	1%
Frequency	Everyday	128	48%
	Once a week	90	34%
	Twice a week	30	11%
	Twice a month	17	7%
	Other	0	0%
Self-Service Banking	ACLEDA Bank	265	100%
	Other	0	0%

*Level of agreement*

The statistics in Table 4 illustrates the level of agreement of each variable. Table 4 includes the type of variable, minimum, maximum, mean, standard deviation (SD), and status of

agreement analysis. The mean of each variable ranges from the lowest one of 6.1509, which is the tangibility with a standard deviation of 0.85272, to the highest of 6.2472, which is a security with a standard deviation of 0.80024. Below is the seven-point rating scale and its classification. The table 4 illustrates the respondent's level of agreement on the measurement of each variable inspires customer to use self-service banking as a result, all items were stated as "Strongly Agree".

Table 4: Level of Agreement

Variable	Minimum	Maximum	Mean	Std. Deviation	Level of Agreement
Customer Satisfaction (CS)	1.00	7.00	6.2453	0.80141	Strongly Agree
Tangibility (TAN)	1.00	7.00	6.1509	0.85272	Strongly Agree
Reliability (REL)	1.00	7.00	6.1962	0.81602	Strongly Agree
Responsiveness (RES)	1.00	7.00	6.1774	0.80755	Strongly Agree
Empathy (EMP)	1.00	7.00	6.1906	0.83286	Strongly Agree
Security (SEC)	1.00	7.00	6.2472	0.80024	Strongly Agree
Perceived Benefit (PB)	1.00	7.00	6.2283	0.80702	Strongly Agree

\*Note: Neutral: 3.58-4.42, Somewhat Agree: 4.43 – 5.28, Agree: 5.29 – 6.14, Strongly Agree: 6.15 – 7.00

### Correlation analysis

Correlation analysis was used to test the correlation level and validity between all constructs, which brought seven constructs into testing in this research. According to Pearson (1926), the correlation's values range between -1 to +1, meaning that the closer the number in each variable reaches nearly +1, the stronger the correlation.

Table 5 showcased that all variables are significantly correlated at the significance level of 0.01 (2-tailed). The results also illustrated the positive correlations between variables, with the lowest of 0.756 of Reliability toward Customer Satisfaction and the highest of 0.909 of Security with Customer Satisfaction.

Table 5: Pearson Correlation Matrix

Variable	TAN	REL	RES	EMP	SEC	PB	CS
TAN	1						
REL	0.876**	1					
RES	0.853**	0.882**	1				
EMP	0.870**	0.842**	0.903**	1			
SEC	0.857**	0.883**	0.886**	0.901**	1		
PB	0.841**	0.828**	0.873**	0.893**	0.909**	1	
CS	0.821**	0.756**	0.819**	0.852**	0.809**	0.824**	1

\*\* . Correlation is significant at the 0.01 level (2-tailed).

*Linear regression analysis*

Regression analysis is a statistical method for estimating the relationship between a dependent variable and one or more independent variables. In addition, it can be used to forecast an outcome variable and to measure the strength of the relationship between variables.

*Significant test of model fitness*

To find the overall significance of the variable, the model fits because the p-value was 0.000, so it rejected the null hypothesis. According to Sellke (2001), the null hypothesis is rejected when the p-value is between 0 and 0.05. Otherwise, it is true. At least, one independent variable influenced the dependent variable.

Table 6: Result of ANOVA of Model Fitness

Model	Sum of Squares	df	Mean Square	F	Sig.
Regression	130.100	6	21.683	141.783	0.000
Residual	39.457	258	0.153		
Total	169.557	264			

The ANOVA output was examined to check whether the proposed model was feasible. Table 6 showed that the overall model was significant (F = 141.783, p value = 0.000). The results showed that at least one or more independent variables statistically significantly impacted Customer Satisfaction (dependent variable).

Table 7: Model Summary

Model	R	R Square	Adjusted R Square	Std. Error of the Estimate
1	0.876	0.767	0.762	0.391

a. Predictors: (Constant), PB, REL, TAN, RES, EMP, SEC

As shown in Table 7, the value of R is 0.876, and the R square is 0.767. Thus, the whole model explains the variability of the dependent variables around 76 %.

*Regression analysis*

Table 8 shows the Unstandardized Beta Coefficients representing each variable's contribution to the model. The Beta Coefficients and p-value showed the impact of the independent variables on the dependent variables. The higher the absolute value of beta coefficients, the stronger the effect. The table confirmed that Tangibility, Reliability, Responsiveness, Empathy, and Perceived Benefit significantly impact customer satisfaction. Their demonstrations are that Tangibility ( $\beta = 0.295$ ,  $p = 0.000$ ), Reliability ( $\beta = -0.156$ ,  $p = 0.045$ ), Responsiveness ( $\beta = 0.179$ ,  $p = 0.034$ ), Empathy ( $\beta = 0.339$ ,  $p = 0.000$ ), and Perceived Benefit ( $\beta = 0.198$ ,  $p = 0.014$ )

have a significant effect on customer satisfaction. On the other hand, Security ( $\beta = 0.022$ ,  $p = 0.814$ ) does not have a significant effect on customer satisfaction.

Table 8: Regression of Self-Service Banking

Model	Unstandardized Coefficients		Standardized Coefficients	t	Sig.
	B	Std. Error	Beta		
1 (Constant)	0.825	0.196		4.212	0.000
TAN	0.295	0.069	0.314	4.289	0.000
REL	-0.156	0.078	-0.159	-2.013	0.045
RES	0.179	0.084	0.180	2.129	0.034
EMP	0.339	0.085	0.352	3.998	0.000
SEC	0.022	0.092	0.022	0.236	0.814
PB	0.198	0.081	0.200	2.462	0.014

Dependent Variable: CS

### Hypothesis testing

Table 9 showcased the result from the tested hypotheses in the regression analysis which indicated that five hypotheses were supported (H1, H2, H3, H4, and H6) and H5 were not supported.

Table 9: Results of Hypothesis Testing

Hypothesis	Sig.	Result
H1: The tangibility of self-service banking has a significant positive effect on customer satisfaction	0.000	Supported
H2: The reliability of self-service banking has a significant positive effect on customer satisfaction	0.045	Supported
H3: The responsiveness of self-service banking has a significant positive effect on customer satisfaction	0.034	Supported
H4: The Empathy of self-service banking has a significant positive effect on customer satisfaction	0.000	Supported
H5: The Security of self-service banking has a significant positive effect on customer satisfaction	0.814	Not Supported
H6: The perceived benefit of self-service banking has a significant positive effect on customer satisfaction	0.001	Supported

### Discussions

The regression results indicated that Tangibility, Reliability, Responsiveness, Empathy, and Perceived Benefit had the positive effect on self-service banking. According to the previous study by Panda and Das (2014), Tangibility and Empathy are significant variables in influencing external

customer satisfaction. Perceived Benefit also significantly affects customer satisfaction (Khan , 2015). This study revealed that customers are interested in the physical appearance of self-service banking (Tangibility). In addition, self-service banking also reduces customer queues when they want to process the transaction by themselves. The customers can make payment quickly within a minute and more efficiently (Empathy). Likewise, the self-service allows customers to self-check their transactions through various things such as smartphones and other facilities (Perceived Benefit). Moreover, responsiveness and Reliability are also significant variables in influencing external customer satisfaction (Alan, 2016) and customer satisfaction toward the banking hall of ACLEDA Bank Plc. (Taing et al., 2021). However, Security do not significantly affect this study since the customer needs a better experience with the security of the self-service banking as it was far or at an uncrowded place. Therefore, self-service banking needs to be more secure to process the transaction.

## 5. Conclusion and implications

### *Conclusion*

This study has attempted to study the effect of self-service banking quality on customer satisfaction. Self-service banking was not recent innovation; it has been popular among European and South American countries for years. As self-service banking keeps growing sustainably, it is also popular among ASEAN countries. Besides raising self-service banking in Cambodia, the researchers wanted to experiment with customer satisfaction toward self-service banking quality. This study aimed to identify customer satisfaction with self-service banking quality by adopting the SERVQUAL Model developed by Parasuraman et al. (1988). This study used a quantitative method to obtain primary data from 265 respondents living in Phnom Penh and used a structured questionnaire to collect primary data from customers of ACLEDA Bank Plc. in Phnom Penh, Cambodia. Regression results illustrated that Tangibility, Reliability, Responsiveness, Empathy, and Perceived Benefits were statistically significant and had an excellent ratio to customer satisfaction, while Security did not influence customer satisfaction with self-service banking.

### *Implications*

#### Theoretical implications

This study used four dimensions of SERVQUAL model (Tangibility, Reliability, Responsiveness, and Empathy) to investigate the behavioral intention by including two more dimensions (Perceived Benefit and Security). It found significant influences on behavioral intention among those dimensions except Security. Thus, the SERVQUAL Model is worth adopting in the study on behavioral intention of Cambodian customers to use self-service banking.



## Practical implications

This study's results showed that Tangibility, Reliability, Responsiveness, Empathy, and Perceived Benefit influence customers' behavioral intention, so banks should focus on these factors to increase the level of self-service banking satisfaction.

## *Recommendations*

Several studies indicated that self-service banking has dominated the banking industry in the last ten years, but it still needs some improvement in order to grow further and to enhance customer satisfaction in living a normal lifestyle. Additionally, customers' tangibility and reliability can be the best way for bankers to fulfill their needs as they should be. Banks would like to get customers' satisfaction, but receiving complaints from them is what banks need to satisfy them. When things are going well, the number of complaints will decrease as customers' wish is the command. Lastly, to fulfill customer satisfaction, banks should actively follow the trend of technology and renovation. Then the customers will come and spread their experience of using it.

## *Limitations and suggestions for further research*

The study positively contributed to the bank learning about factors affecting customer satisfaction regarding self-service banking quality. However, this study also has limitations. Based on the study, this research uses a quantitative method. However, future researchers should use qualitative, mixed methods, or another model besides using the SERVQUAL Model to make it more critical and broaden the effectiveness. The study focused on how self-service banking quality on customer satisfaction. However, some other factors can also affect customer satisfaction; thus, future researchers are recommended to consider different obstacles that impact customer satisfaction. Future researchers should also expand their research to different geographical areas, such as provinces and rural areas, to determine a larger sample size to offer more generalizable findings.

## References

- Agbor, J. M. (2011). *The Relationship between Customer Satisfaction and Service Quality: a study of three Service sectors in Umeå*.
- Bernieri, F. J. (1988). Coordinated movement and rapport in teacher-student interactions. *Journal of Nonverbal Behavior*, 12(2), 120–138.
- Charles, K. K. S. (2015). Determinants of Self Service Banking Technology in Kenya. *International Journal of Management Technology*, 3(1), 39–56.
- Churchill Jr, G. A., & Surprenant, C. (1982). An investigation into the determinants of customer satisfaction. *Journal of Marketing Research*, 19(4), 491–504.

- Claude, M. J. (2022). Effect of Electronic Banking on Customer Satisfaction in Rwanda: Case of Bank of Kigali Headquarter. *Scholars Journal of Economics, Business and Management, 1*, 14–29.
- Dabholkar, P. A. (1996). Consumer evaluations of new technology-based self-service options: an investigation of alternative models of service quality. *International Journal of Research in Marketing, 13*(1), 29–51.
- Davis, F. D. (1989). Perceived usefulness, perceived ease of use, and user acceptance of information technology. *MIS Quarterly: Management Information Systems, 13*(3), 319–339. <https://doi.org/10.2307/249008>
- Giao, H. N. K., Vuong, B. N., & others. (2019). *Giáo Trình Cao Học Phương Pháp Nghiên Cứu Trong Kinh Doanh Cập Nhật SmartPLS*.
- Gorry, G. A., & Westbrook, R. A. (2011). Can you hear me now? Learning from customer stories. *Business Horizons, 54*(6), 575–584.
- Green, S. B. (1991). How many subjects does it take to do a regression analysis. *Multivariate Behavioral Research, 26*(3), 499–510.
- Gremler, D. D., & Gwinner, K. P. (2008). Rapport-building behaviors used by retail employees. *Journal of Retailing, 84*(3), 308–324.
- Homburg, C., Koschate, N., & Hoyer, W. D. (2006). The role of cognition and affect in the formation of customer satisfaction: a dynamic perspective. *Journal of Marketing, 70*(3), 21–31.
- Jamal, A. (2004). Retail banking and customer behaviour: a study of self concept, satisfaction and technology usage. *The International Review of Retail, Distribution and Consumer Research, 14*(3), 357–379.
- JM Tharaka Madhusanka, T. P. (2018). *A comparative analysis of customer satisfaction on self service technology channels between state and private banks*.
- Keller, K. L., & Lehmann, D. R. (2006). Brands and branding: Research findings and future priorities. *Marketing Science, 25*(6), 740–759.
- Kotler, P. (2012). *Kotler on marketing*. Simon and Schuster.
- Labaree, R. V. (2009). *Research guides: Organizing your social sciences research paper: The research problem/question*.
- Madu, C. N., & Madu, A. A. (2002). Dimensions of e-quality. *International Journal of Quality & Reliability Management, 19*(3), 246–258.
- Mathwick, C., Malhotra, N. K., & Rigdon, E. (2002). The effect of dynamic retail experiences on experiential perceptions of value: an Internet and catalog comparison. *Journal of Retailing, 78*(1), 51–60.
- Meuter, M. L., Ostrom, A. L., Roundtree, R. I., & Bitner, M. J. (2000). Self-service technologies: understanding customer satisfaction with technology-based service encounters. *Journal of Marketing, 64*(3), 50–64.
- Nornng, S. (2022). Factors Influencing Mobile Banking Adoption in Cambodia: The Structuring

- of TAM, DIT, and Trust with TPB. *Asian Journal of Business Research Volume, 12*(3).
- Nunnally, J. C. (1994). The assessment of reliability. *Psychometric Theory*.
- Oliver, R. L. (1980). A cognitive model of the antecedents and consequences of satisfaction decisions. *Journal of Marketing Research, 17*(4), 460–469.
- Oliver, R. L. (1981). Measurement and evaluation of satisfaction processes in retail settings. *Journal of Retailing*.
- Parasuraman, A., Berry, L. L., & Zeithaml, V. A. (1991). Refinement and reassessment of the SERVQUAL scale. *Journal of Retailing, 67*(4), 420.
- Parasuraman, A., Zeithaml, V. A., & Berry, L. (1988). SERVQUAL: A multiple-item scale for measuring consumer perceptions of service quality. *1988, 64*(1), 12–40.
- Parasuraman, A., Zeithaml, V. A., & Berry, L. L. (1985). A Conceptual Model of Service Quality and Its Implications for Future Research. *Journal of Marketing, 49*(4), 41. <https://doi.org/10.2307/1251430>
- Pearson, K. (1926). On the coefficient of racial likeness. *Biometrika, 105*–117.
- Reddy, A. C., Buskirk, B. D., & Kaicker, A. (1993). Tangibilizing the intangibles: some strategies for services marketing. *Journal of Services Marketing*.
- Salihu, A., Metin, H., Hajrizi, E., & Ahmeti, M. (2019). The effect of security and ease of use on reducing the problems/deficiencies of Electronic Banking Services. *IFAC-PapersOnLine, 52*(25), 159–163.
- Sannes, R. (2001). Self-service banking: value creation models and information exchange. *Informing Science, 4*, 139.
- Sellke, T., Bayarri, M. J., & Berger, J. O. (2001). Calibration of  $p$  values for testing precise null hypotheses. *The American Statistician, 55*(1), 62–71.
- Stocchi, L., Michaelidou, N., & Micevski, M. (2019). Drivers and outcomes of branded mobile app usage intention. *Journal of Product & Brand Management, 28*(1), 28–49.
- Sultana, S., & Das, T. I. S. (2016). Measuring customer satisfaction through SERVQUAL model: A study on beauty parlors in Chittagong. *European Journal of Business and Management, 8*(35), 97–108.
- Taing, C., Duch, N., & Phoeun, M. (2021). The Impact of Digital Transformation on the Use of Banking Services. *AIB Research Series, 1*.
- Tax, S. S., Brown, S. W., & Chandrashekar, M. (1998). Customer evaluations of service complaint experiences: implications for relationship marketing. *Journal of Marketing, 62*(2), 60–76.
- Tojib, D., & Tsarenko, Y. (2012). Post-adoption modeling of advanced mobile service use. *Journal of Business Research, 65*(7), 922–928.
- Trochim, W. M. K. (2006). An Evaluation Culture. *Research Methods Knowledge Base*.
- Tse, D. K., & Wilton, P. C. (1988). Models of consumer satisfaction formation: An extension. *Journal of Marketing Research, 25*(2), 204–212.
- Ursachi, G., Horodnic, I. A., & Zait, A. (2015). How reliable are measurement scales? External

- factors with indirect influence on reliability estimators. *Procedia Economics and Finance*, 20, 679–686.
- Vuong, B. N., Hieu, V. T., & Trang, N. T. T. (2020). An empirical analysis of mobile banking adoption in Vietnam. *Gestão e Sociedade*, 14(37), 3365–3393.
- Wilson, N. (2019). The impact of perceived usefulness and perceived ease-of-use toward repurchase intention in the Indonesian e-commerce industry. *Jurnal Manajemen Indonesia*, 19(3), 241–249.



## ● ACLEDA INSTITUTE OF BUSINESS ●

📍 #1397, Phnom Penh - Hanoi Friendship Blvd., Phum Anlong Kngan,  
Sangkat Khmuonh, Khan Saensokh, Phnom Penh, Kingdom of Cambodia.

☎ 023 999 944 / 023 986 937 / 015 600 410

🌐 [www.acleda-aib.edu.kh](http://www.acleda-aib.edu.kh)

✉ [info@acleda-aib.edu.kh](mailto:info@acleda-aib.edu.kh)

📌 ACLEDA INSTITUTE OF BUSINESS